

Proportional Valves

Proportional solenoid valves for pressure and flow control



Electro-Proportional Valves

Section Contents

Model	Typical Application Pressure bar (psi)	Rated Flow L/min (USgpm)	Page
Proportional Valve Cartridges – Introduction, Features and Benefits.....			B-3
Proportional Flow Controls, Poppet Type			
EPV10.....	350 (5000).....	30 (8).....	B-4
EPV16.....	280 (4000).....	160 (42).....	B-8
Proportional Flow Controls, Spool Type			
EFV1-10-O.....	210 (3000).....	38 (10).....	B-14
EFV1-10-C.....	210 (3000).....	38 (10).....	B-17
EFV1-12-O.....	210 (3000).....	104 (27.5).....	B-20
EFV1-12-C.....	210 (3000).....	77 (20.6).....	B-23
EFV2-12-O.....	210 (3000).....	114 (30).....	B-26
EFV2-12-C.....	210 (3000).....	114 (30).....	B-29
Proportional Relief			
ERV2-10.....	35 (500).....	2,8 (0.75).....	B-32
ERV3-10.....	210 (3000).....	0,8 (0.25).....	B-34
ERV1-10 spool type.....	240 (3500).....	60 (15).....	B-36
ERV1-16 spool type.....	210 (3000).....	132 (35).....	B-38
Proportional Pressure Reducing/Relieving			
EPRV2-8.....	35 (500).....	7,6 (2).....	B-40
EPRV1-10.....	35 (500).....	7,6 (2).....	B-42
EPRV3-10.....	210 (3000).....	30 (8).....	B-44
EPRV1-16.....	35 (500).....	38 (10).....	B-46
Slip-In Pilot Control Valves			
758 Series Flow Regulator.....	100 (1450).....	10 (2.6).....	B-48
758 Series Pressure Regulator.....	60 (870).....	10 (2.6).....	B-50

Note

Proportional valve solenoid coils and electronic valve drivers are covered in section C of this Catalog.

Electro-Proportional Valves

Section Introduction

This section gives basic specifications for the complete line of Vicker's screw-in proportional control valves. Its purpose is to provide a quick, convenient reference tool when choosing proportional valves or when designing a system using these components.

The **EPV10** has several outstanding performance features which give it a unique position in the screw-in cartridge valve market. Valve gain linearity, flow force pressure compensation characteristics above 20 bar (300 psi) and low internal leakage.

The **EPV16** is a proportionally controlled two-way poppet type valve. The main poppet amplifies a small flow through the pilot circuit and is comparable to a transistor. As the transistor uses small currents to control larger currents, the hydraulic valve transistor or VALVISTOR uses the pilotflow to control the main stage flow with servo-like response flow to control.

The **EFV1** is a proportionally controlled two-way, spool type flow control valve. Technically the valve is not pressure compensated, but at high differential pressures it is partially flow force pressure compensated.

The **EFV2** is a three port, pressure compensated, proportional flow control valve. The valve can be used as a priority flow regulator, with regulated flow being supplied to port 3 and excess flow being by-passed to port 2. If port 2 is blocked the valve functions as a restrictive, 2 way, pressure compensated flow regulator.

The **ERV1-10** is an electric, proportionally controlled, internally pilot operated, spool type screw-in relief valve. It is capable of han-

dling flows from 3,8-60,0 L/min (1-15 USgpm) at pressures from 35-210 bar (500-3000 psi). Also available is an **ERV1-16** which is capable of handling flows from 7,6-132 L/min. (2-35 USgpm) at pressures from 35-210 bar (100-500 psi).

The **ERV2-10** is a low flow electric proportionally controlled relief valve similar to the ERV1-10. This valve is rated for flows from 0,2-2,8 L/min (0.05-0.75 USgpm) and pressures up to 35 bar (500 psi).

The **ERV3-10** is a low flow electric proportionally controlled relief valve similar to the ERV2-10. This valve is rated for flows up to 0,8 L/min (0.20 USgpm) and pressures up to 207 bar (3000 psi).

The **EPRV2-8** is an electric, proportionally controlled, direct acting spool type, screw-in pressure reducing/relieving valve. It is capable of handling flows from 0-7,6 L/min (0-2 USgpm) at set pressures from 0-22 bar (0-320 psi).

The **EPRV1-10** is an electric, proportionally controlled, internally pilot operated, spool type, screw-in pressure reducing/relieving valve. It is capable of handling flows from 0-7,6 L/min (0-2 USgpm) at set pressures from 14-35 bar (200-500 psi). Also available is an **ERV1-16** which is capable of handling flows from 0-38 L/min (0-10 USgpm) at set pressures from 14-35 bar (200-500 psi).

The **EPRV3-10** is an electric, proportionally controlled, internally pilot operated, spool type, screw-in pressure reducing/relieving valve. It is capable of handling flows from 0-30 L/min (0-8 USgpm) at set pressures from 35-207 bar (500-3000 psi).

Vickers proportional pressure and flow control valves are

designed to be easily controlled by the simplest of DC electrical devices such as a 12 volt battery and a potentiometer.

Varying the voltage at the coil is one of the simplest means of control available. Any of the Vickers DC coils will work on most of these valves simply by varying the voltage between 0 and 75% of the rated coil voltage. It should be noted that as the operating temperature of a coil increases, the solenoid force decreases. Therefore if the voltage is held constant as the coil heats up then valve pressure (or flow) will change.

Electrical current controls with PWM are recommended for all Eaton proportional valves.

Closed-loop electrical control with feedback from the parameter to be monitored will provide the most accurate control.

Valve Features and Benefits

- Products in this catalog have been fatigue tested to one million cycles at 132% or 10 million cycles at 115% of rated pressure
- All operating parts are hardened steel, ground and honed for long life and low leakage
- Designed for maximum flexibility and minimal space requirements
- All exposed cartridge surfaces are zinc dichromate plated to resist corrosion
- Reliable, economical and compact
- Rated flows up to 160 L/min (42 USgpm)
- Optional nose-in, side-out or side-in, nose out flow direction (EPV16 series)

Coil Features and Benefits

The valves in this catalog are offered with a choice of two or three standard voltages and several types of electrical connections. For other coil ratings and connections, consult your Eaton applications engineer.

- Variety of voltages and terminations
- Coils are interchangeable for serviceability on the EPV10 and EPV16. Coils are interchangeable for serviceability on the ERV1-10, EPV1-16, EPRV1-10 and EPRV1-16
- Compact, one-piece weather-proof encapsulated design. Eliminates need for extra seals
- An arc suppression diode molded into the coil is available as a standard option on ERV, EPRV and EFV valves

Fluid Cleanliness

Proper fluid condition is essential for long and satisfactory life of hydraulic components and systems. Hydraulic fluid must have the correct balance of cleanliness, materials, and additives for protection against wear of components, elevated viscosity, and inclusion of air.



WARNING

Application of these products beyond published performance specifications may cause valve malfunction which may result in personal injury and/or damage to the machine.



WARNING

For pressures over 210 bar (3000 psi) use steel housing.

EPV10

Proportional flow control valve (poppet type)

Description

The EPV10 is a direct acting, uni-directional, poppet type, 2-way, 2-position, normally closed proportional flow control valve.

Operation

In the de-energized position, flow is blocked from port 2 to port 1, with no reverse flow permitted. When energized, flow is

allowed from port 2 to port 1 in direct proportion to the current applied to the solenoid coil.

Functional Symbol

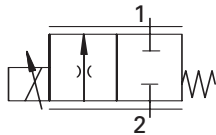

Sectional View

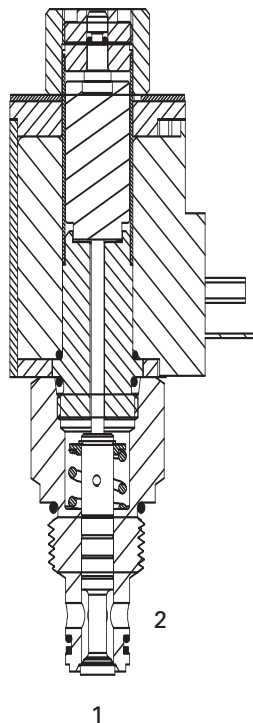

RATINGS AND SPECIFICATIONS

Performance data is typical with fluid at 21,8 cSt (105 SUS) and 49°C (120°F)

Typical application pressure (at port 2)	350 bar (5000 psi)
Cartridge fatigue pressure (infinite life)	350 bar (5000 psi)
Rated flow	0 - 30 L/min (0 - 8 USgpm)
Operating ambient temperature	-30° to 90°C (-22° to 194°F)
Cavity	C-10-2
Fluids	Anti-wear hydraulic oils with Buna-N seals (standard) Phosphate esters (non-alkyl) with Viton® seals are available by request <small>Viton is a registered trademark of E.I. DuPont</small>
Weight cartridge only	0,78 kg (1.72 lbs)
Filtration	70 - 210 bar (1000 - 3000 psi) Cleanliness code 17/15/12 210+ bar (3000+ psi) Cleanliness code 15/13/11
Standard housing materials	Aluminum or Steel
Typical hysteresis	Less than 4% of rated current at 10 bar pressure drop – Pulse Width Modulated (PWM)
Internal leakage	10 cm ³ maximum @ 140 bar (2000 psi) and oil viscosity of 30 cSt
Oil viscosity range	10 - 800 cSt
Nominal supply voltage	12 or 24 VDC
Threshold current	from 300 - 600 mA (12 VDC) from 150 - 300 mA (24 VDC)
Coil current @ max flow	0.7 amps max @ 24 VDC 1.4 amps max @ 12 VDC
Recommended PWM frequency	100 - 200 Hz application dependent, 150 Hz typ
Coil resistance @ 20°C (86°F)	12V-6.5Ω 24V-25.0Ω
Power consumption @ rated current and 20°C coil temperature	12V-12.8 watts 24V-12.8 watts
Cartridge seal kit	02-317580 (Buna-N)

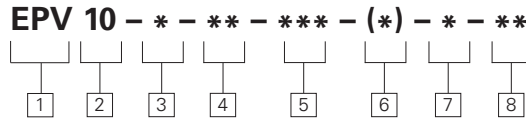

1 Function

EPV - Electro-proportional flow control valve, poppet type

2 Size

10 - 10 Size

3 Valve housing material

Omit for cartridge only

A - Aluminum

S - Steel

Maximum operating pressure for aluminum housing is 210 bar (3000 psi).



Aluminum housings can be used for pressures up to 210 bar (3000

psi). Steel housings **must** be used for operating pressures **above** 210 bar (3000 psi).

Dimensions

mm (inch)

Valve is shown with "U" coil. See Section C for coil information. Torque cartridge in housing

A - 47-54 Nm (35-40 ft. lbs)

S - 68-75 Nm (50-55 ft. lbs)

4 Port size

CODE	PORT SIZE	HOUSING NUMBER	
		Aluminum	Steel
3G	3/8" BSPP	876703	02-175103
6H	SAE 6	876700	—
8H	SAE 8	876701	—
6T	SAE 6	—	02-175100
8T	SAE 8	—	02-175101

See section J for housings.

7 Coil/Connector types

CONNECTOR

Blank - No coil

W - Leadwire (DC only) 02-361830 02-363310

Q - Spade terminals (DC only) 02-361836 02-363311

U - DIN 43650 02-361837 02-363321

Y - Metri-Pack 150 male* 02-361845 02-363322

F - Weather-Pack male 02-361848 02-364328

N - Deutsch DT04-ZP 02-361849 02-364329

*Preferred Packard connector.

5 Voltage rating

12D -12VDC

24D - 24VDC

6 Manual override option*

Blank - No manual override

M - Pin type

S - Screw type

*Manual override is available in two different configurations, either push pin type is used when system pressure does not exceed 210 bar (3000 psi). The screw type can be used at any system pressure. For details see page B-9.

8 Design number

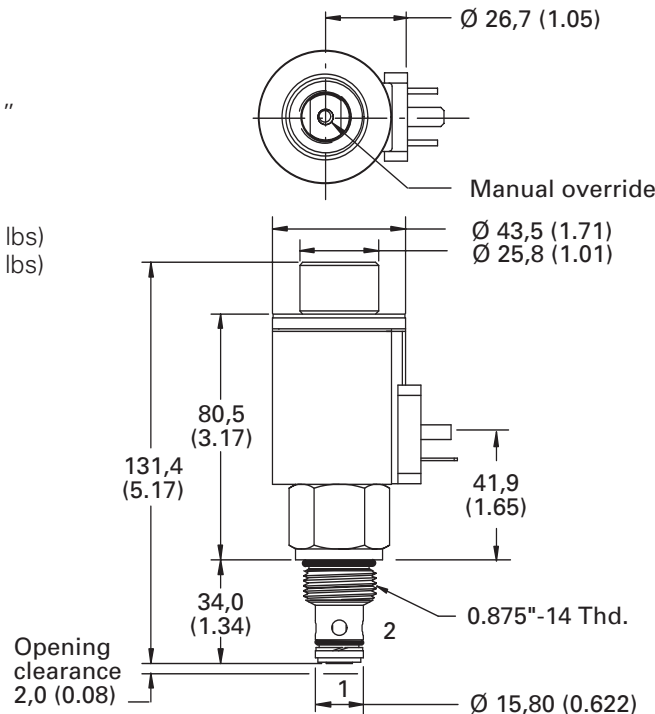

WARNING

The cavity should be machined to the 14,29 (0.562) maximum diameter and 36,00 (1.417) maximum depth. (See cavity, page M-12)



WARNING

When using the "Screw Type" override, care must be taken to return the override back to its neutral position before activating the valve. Failure to take this precaution may result in personal injury or damage to the machine.

Performance Curves

EPV10

Step Response Data

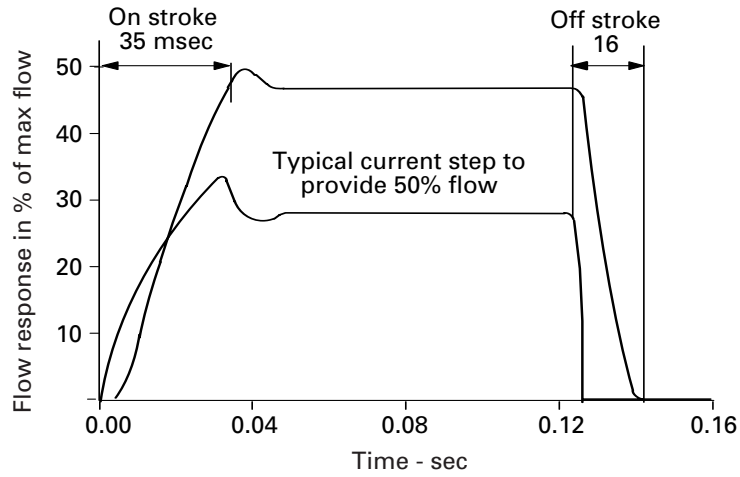

Flow vs Current

With 10 bar differential between inlet and outlet

A - 210 bar (3000 psi) pressure drop from Port 2 to Port 1

B - 10 bar (150 psi) pressure drop from Port 2 to Port 1

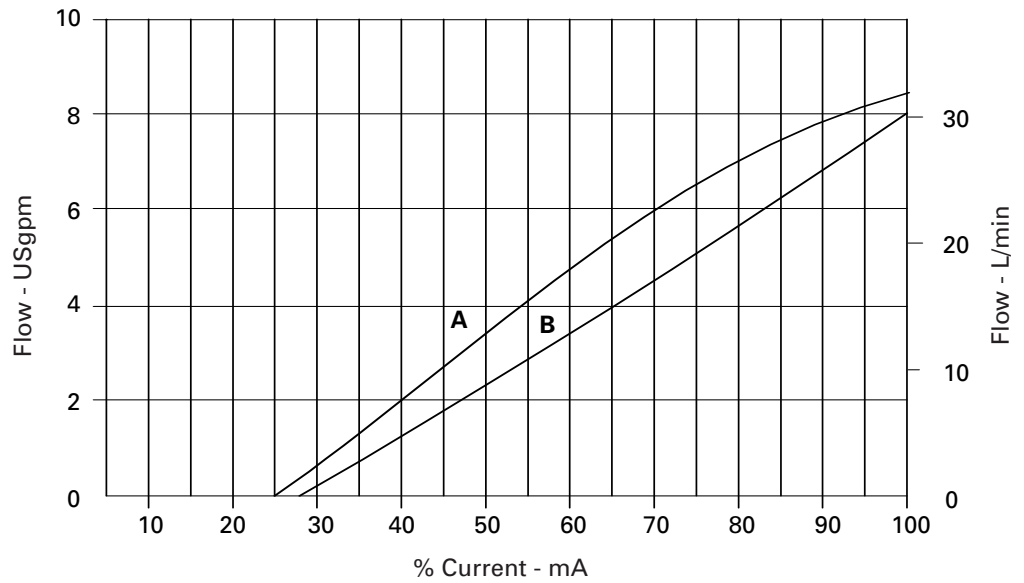

Performance Curves

EPV10

B

Flow vs Pressure Drop

Per % of Input Current

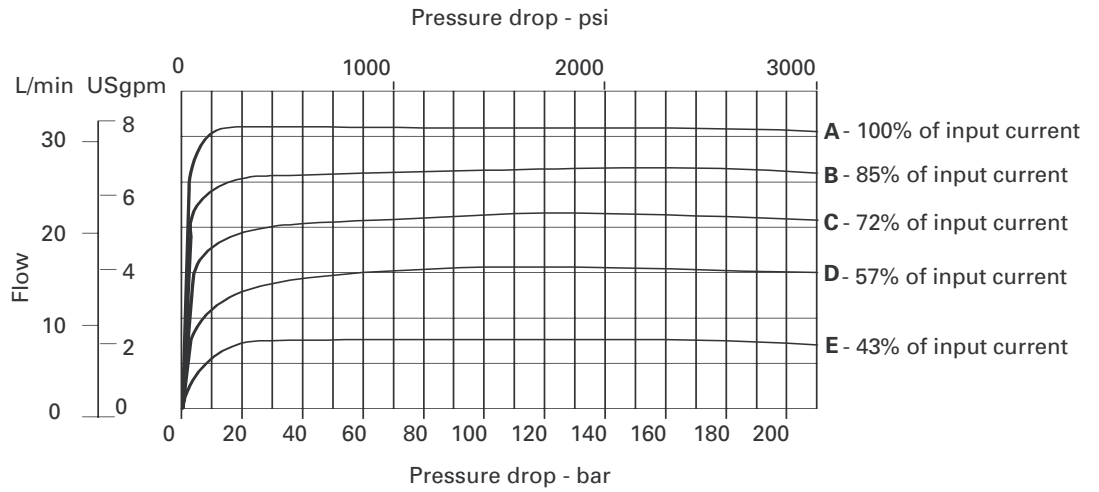

Typical Flow Response

For an amplitude of $\pm 40\%$ maximum stroke (center to offset) about the 50% position.
 $\Delta P = 10 \text{ bar (145 psi)}$

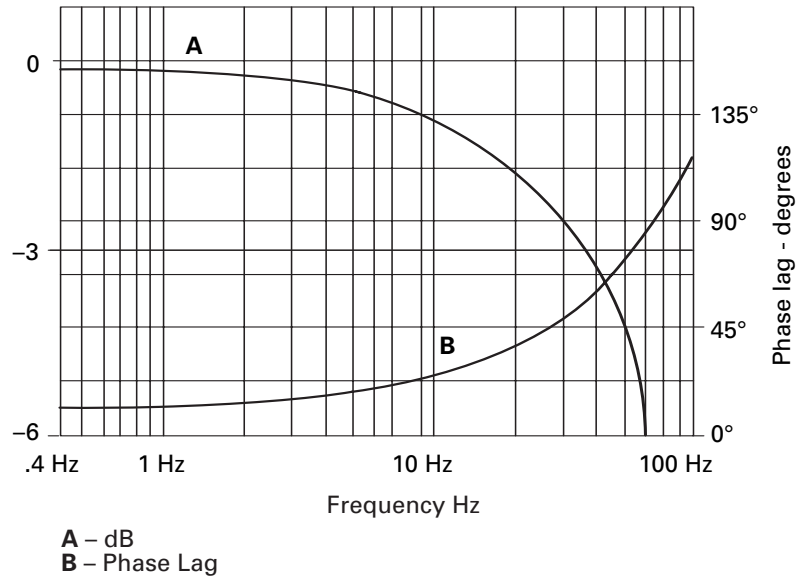

EPV16 Valvistor®

Proportional flow
control valve

Functional Symbols

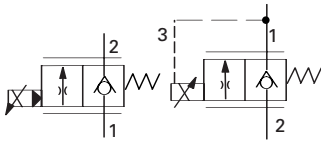

EPV16-A

EPV16-B

Sectional View

EPV16-A Side-out, nose-in

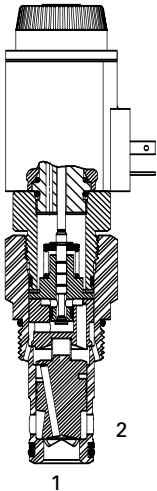

EPV16-B Side-in, nose-out

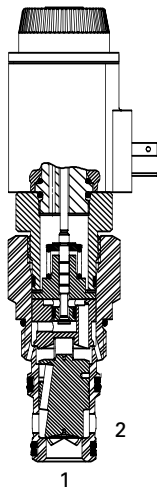

Description

The EPV16 is a 2-way, normally closed, pressure compensated, poppet type, screw-in cartridge electro-proportional flow control valve.

Operation

"A" style (nose in, side out)
- In the de-energized position this valve remains closed from port 1 to port 2. When current is applied to the coil, a controlled increasing flow will be allowed from port 1 to port 2, in proportion to the current applied.

"B" style (side in, nose out)
- in the de-energized position the valve remains closed from port 2 to port 1. When current is applied to the coil, a controlled increasing flow will be allowed from port 2 to port 1. In both examples free reverse flow is allowed in the opposite direction.

RATINGS AND SPECIFICATIONS

Performance data is typical with fluid at 21,8 cSt (105 SUS) and 49°C (120°F)

Typical application pressure	280 bar (4000 psi)
Cartridge fatigue pressure (infinite life)	280 bar (4000 psi) NFA rated
Rated flow	0 to 160 L/min (42 USgpm)
Operating media temperature	-30° to 90°C (-22° to 194°F)
Cavity	C-16-3S (undercut)
Fluids	Antiwear hydraulic oils with Buna-N seals (standard) Phosphate esters (non-alkyl) with Viton® seals are available by request <small>Viton is a registered trademark of E.I. DuPont</small>
Weight cartridge only	1 kg (2.2 lbs)
Filtration	70 - 210 bar (1000 - 3000 psi) Cleanliness code 17/15/12 210+ bar (3000+ psi) Cleanliness code 15/13/11
Standard housing materials	Aluminum or steel
Typical hysteresis	Less than 4% of rated current @ 10 bar pressure drop – Pulse Width Modulated (PWM)
Internal leakage @ 140 bar (2000 psi) and oil viscosity 30cSt	EPV16A 50 cm ³ /min maximum EPV16B 10 cm ³ /min maximum
Oil viscosity range	10 - 800 cSt
Nominal supply voltage	12 or 24 VDC
Threshold current	from 350 - 500 mA (12 VDC) from 175 - 250 mA (24 VDC)
Coil current for maximum flow	0.7 amps @ 24 VDC 1.4 amps @ 12 VDC
Recommended PWM frequency	100 - 200 Hz application dependent, 150 Hz typ
Coil resistance @ 20°C (68°F)	12V-6.5Ω/24V-25.0Ω
Power consumption @ rated current and 20°C coil temperature	12V-12.8 watts 24V-12.8 watts
Cartridge seal kit	02-154069 (Buna-N)

EPV 16 - * - ** - * - * - *** - * - * - ****

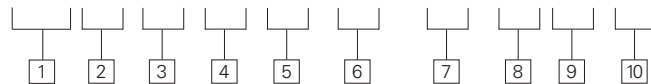

1 Function
EPV - Electro-proportional flow control valve, poppet type

2 Size
16 - 16 Size

3 Flow direction
A - Nose-in, side-out
B - Side-in, nose-out

4 Rated flow @ 10 bar ΔP
04 - 40 L/min (10.5 USgpm)
06 - 60 L/min (16 USgpm)
10 - 100 L/min (26 USgpm)
16 - 160 L/min (42 USgpm)

5 Valve housing material
 Omit for cartridge only
A - Aluminum
S - Steel

 Aluminum housings can be used for pressures up to 210 bar (3000 psi). Steel housings **must** be used for operating pressures **above** 210 bar (3000 psi).

M - Pin type manual override option

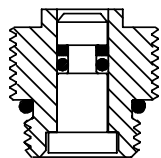

6 Port Size
0 - Cartridge only

CODE	PORT SIZE	HOUSING NUMBER			
		Aluminum EPV16-A	EPV16-B	Steel EPV16-A	EPV16-B
4G	1/2" BSPP	02-185448	02-166607	02-180050	02-165500
6G	3/4" BSPP	02-185449	02-161582	02-180051	02-164931
10H	SAE 10	02-185446	02-170238	—	—
12H	SAE 12	02-185447	02-166609	—	—
10T	SAE 10	—	—	02-180048	02-161983
12T	SAE 12	—	—	02-180049	02-161982
5C	CETOP5 (NFPA D05) Interface (Requires steel body)				

See section J for housings.

7 Voltage rating
12D - 12VDC
24D - 24VDC

8 Manual override option
Blank - No manual override
M - Pin type
S - Screw type

*Manual override is available in two different configurations, either push pin type is used when system pressure does not exceed 210 bar (3000 psi). The screw type can be used at any system pressure.

S - Screw type manual override option

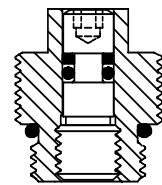

9 Coil/Connector types

CONNECTOR	COIL PART NUMBER	
	12VDC	24VDC
Blank - No coil		
W - Leadwire (DC only)	02-154072	02-154073
Q - Spade terminals (DC only)	02-317154	02-317155
U - DIN 43650	02-154070	02-154071
Y - Metri-Pack 150 male*	02-308808	02-308809
F - Weather-Pack male	02-308810	02-308811
N - Deutsch DT04-2P	02-390736	02-391885

*Preferred Packard connector. See Section C for coil information.

10 Design number



WARNING

When using the "Screw Type" override, care must be taken to return the override back to its neutral position before activating the valve. Failure to take this precaution may result in personal injury or damage to the machine.



CAUTION

A separate check valve is required down stream to isolate the EPV valve from load forces when the EPV is used to hold a load.

Dimensions

EPV16-A

EPV16-A

Nose-in, side-out
mm (inch)

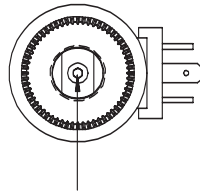

Screw type actuator (shown)
3 mm hex socket

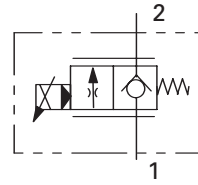

Note

When stand alone housings are used, the following guidelines apply:

- EPV16-A: Port 3 is to be plugged.
- EPV16-B: Port 3 is to be connected to port 1 in order to provide the required feedback flow path.

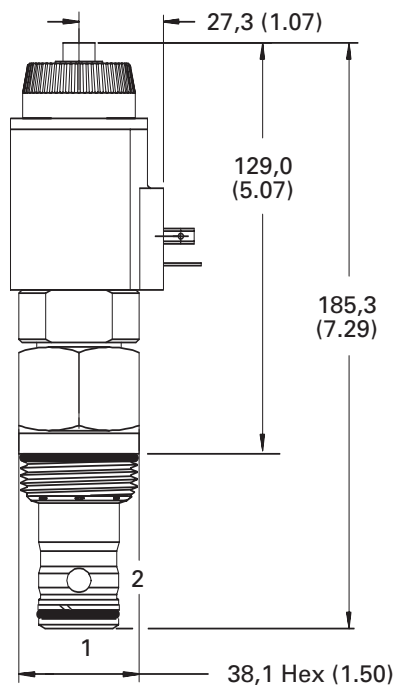

With manual actuator

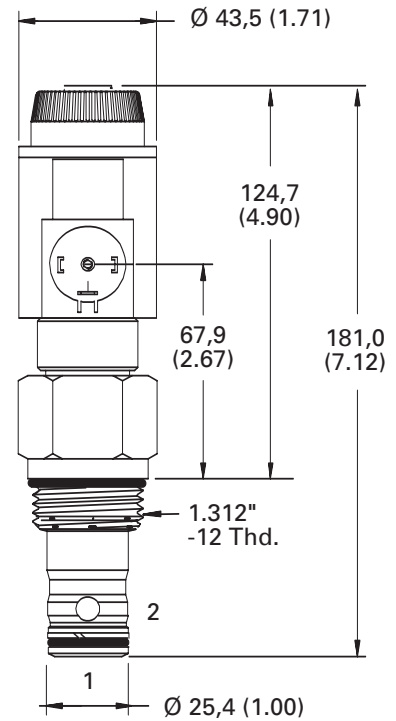

No manual actuator

Valves are shown with "U" coil. See Section C for coil information.

Torque cartridge in aluminum housing 108-122 Nm (80-90 ft. lbs)

Torque cartridge in steel housing 136-149 Nm (100-110 ft. lbs)

Dimensions

EPV16-B

B

EPV16-B

Side-in, nose-out
mm (inch)

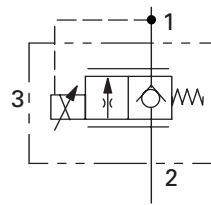
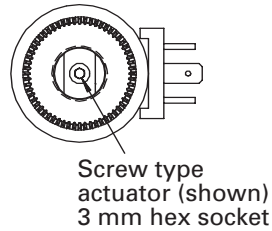

Required external connection with standard C-16-3S cavity

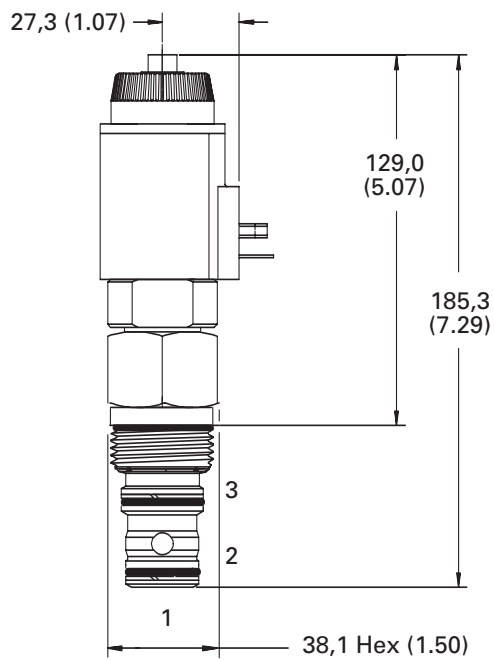

With manual actuator

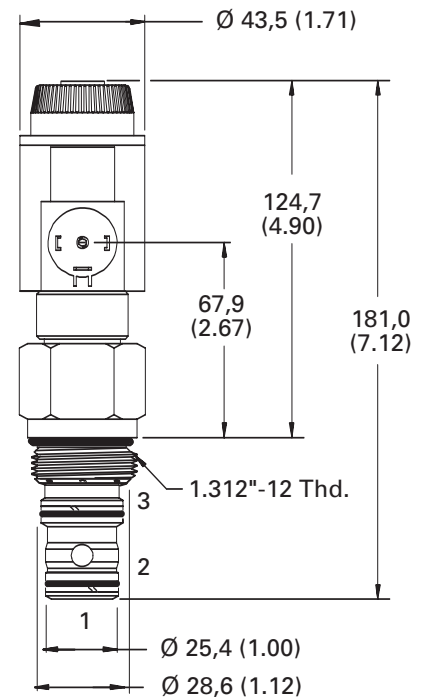

No manual actuator

For EPV16-B (flow 2 to 1), Port 3 must be connected to Port 1 externally to the cartridge, either by passages in the cavity block or external plumbing. When purchased with undercut body, this connection is included in the body and Port 3 is not machined. A separate external port connection is not required for EPV16-A (flow 1 to 2).

Dimensions

EPV16

EPV16-A-***-S-5C-**-D-(*)--12 CETOP 5 Interface

mm (inch)

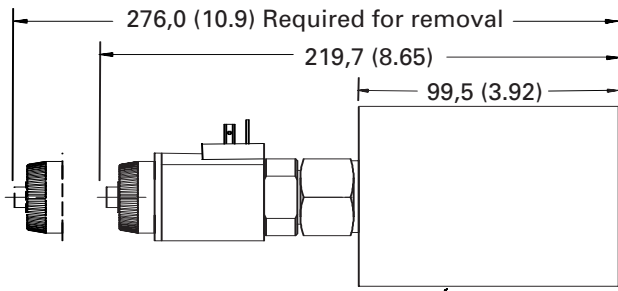

ISO-4401-AC-05-4-A (NFPA D05)
mounting surface

.250-20 UNC x 2.500"
socket head cap screw
(Bolt Kit 255634)
M6 x 60 socket head cap
screw (Bolt Kit 689623)

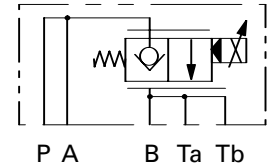
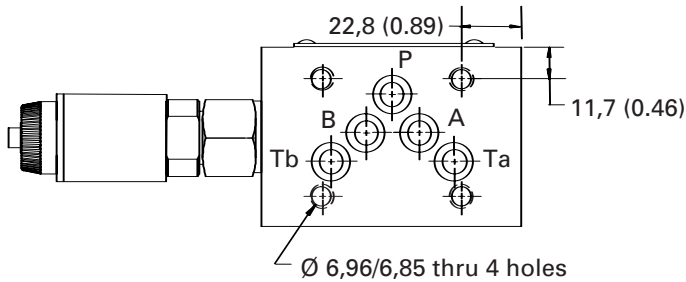
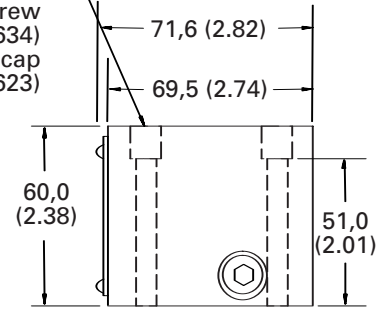

EPV16-B-***-S-5C-**-D-(*)--12 CETOP 5 Interface

mm (inch)

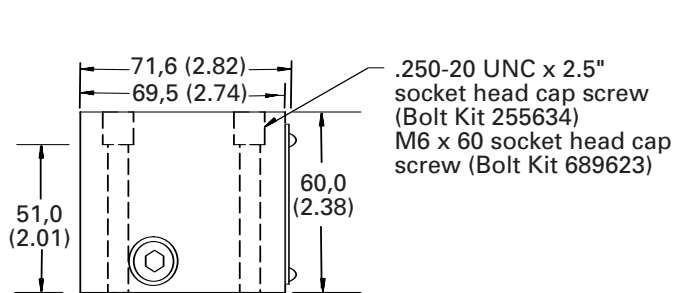

ISO-4401-AC-05-4-A
(NFPA D05)
mounting surface

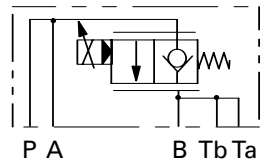
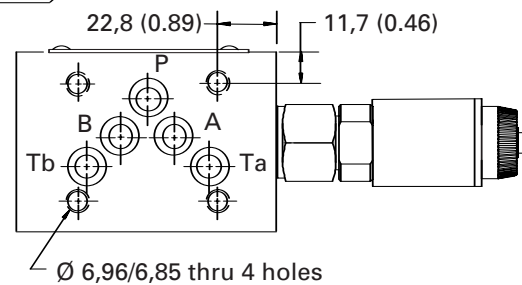
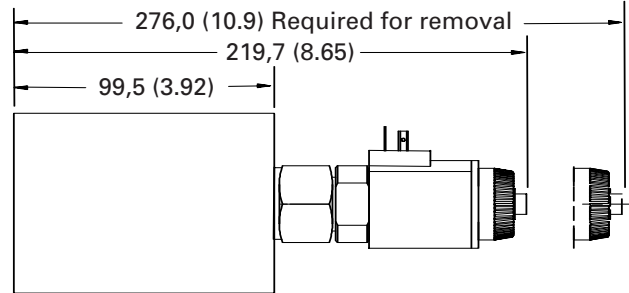

Note

CETOP 5 Seal Kit 02-
319667

Performance Curves

EPV16

B

Typical pressure compensation

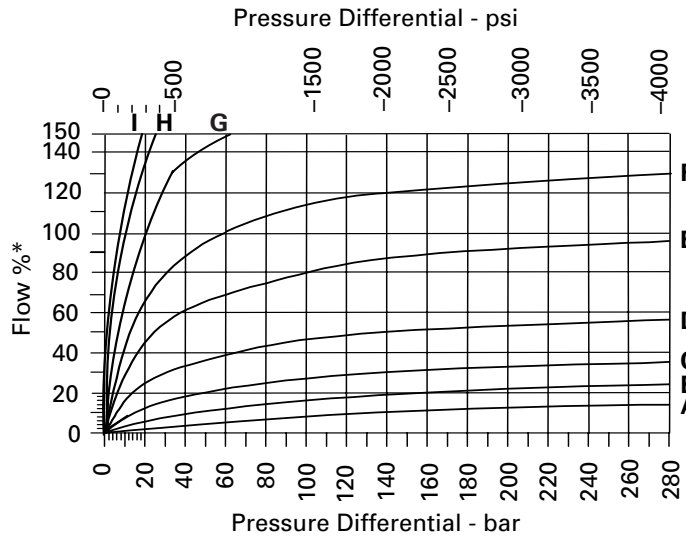

COMMAND CURRENT

	12V	24V
A-	600 mA	300mA
B-	700 mA	350mA
C-	800 mA	400mA
D-	900 mA	450mA
E-	1000 mA	500mA
F-	1100 mA	550mA
G-	1200 mA	600mA
H-	1300 mA	650mA
I-	1400 mA	700mA

* Flow interims of % for each poppet size

Typical metering performance

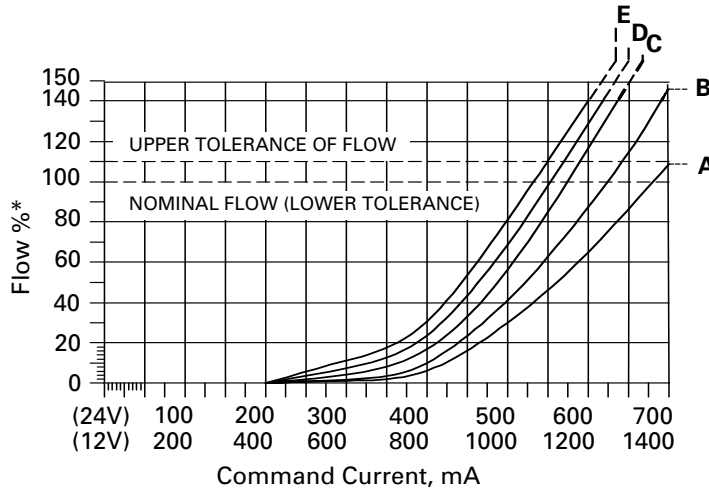

PRESSURE DIFFERENTIAL

	bar	psi
A-	10 bar	150 psi
B-	20 bar	300 psi
C-	50 bar	700 psi
D-	100 bar	1500 psi
E-	200 bar	3000 psi

* Flow interims of % for each poppet size

Step response definition of terms

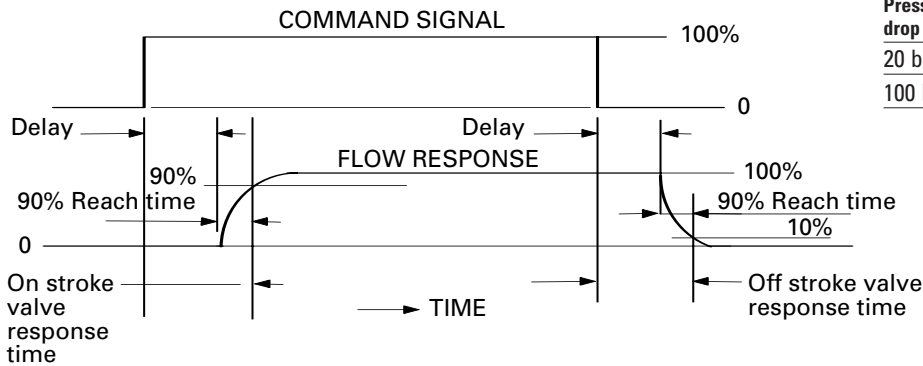

PRESSURE DROP @ 120 L/MIN (30 USGPM)

Pressure drop ΔP	On Stroke Delay/Reach 90%	Off Stroke Delay/Reach 90%
20 bar (290 psi)	24 ms/35ms	5 ms/15 ms
100 bar (1450 psi)	24 ms/17ms	5 ms/7ms

EFV1-10*-0

Proportional flow control valve, normally open, spool type

Description

The EFV1-10*-0** is a normally open, unidirectional, uncompensated, spool type, two way, proportional flow control, screw-in cartridge valve.

Operation

The valve is controlled by current supplied to the coil. At zero current, the valve is fully open from port 2 to port 3. At 1500 to 1600 mA (12V coil) the valve is fully closed. Port 1 is used for pressure balancing the spool and armature and must be blocked in all cases.

The maximum intended pressure drop is 300 PSID. At pressure drops above 300 PSID, almost no increase in flow is obtained. The intended flow direction is from port 2 to port 3. Operation of the valve with flow from port 3 to port 2 will produce flow vs current and flow vs pressure drop curves that are significantly

different from those obtained with flow from port 2 to port 3. Since the spool and armature are pressure balanced, the operating pressure does not affect the operating characteristics of the valve. The operating point of the valve is determined only by current, pressure drop and temperature.

Functional Symbol

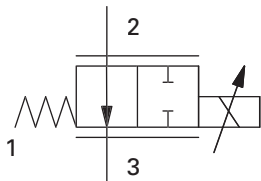

Profile View

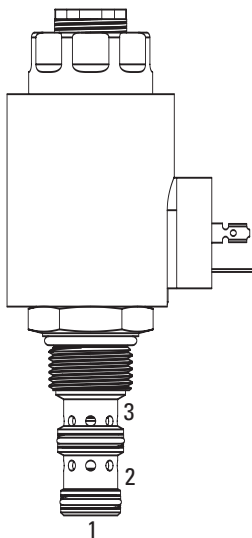

Note

Port 1 is unused and must be plugged.

RATINGS AND SPECIFICATIONS

Performance data is typical with DTE 24 hydraulic fluid at 120°F

Typical application pressure	210 bar (3000 psi)
Cartridge endurance rating	1 million cycles
Cartridge fatigue pressure rating (NFPA/T2.6.1 R2-2000)	210 bar (3000 psi)
Rated maximum flow at 160 PSID	Flow rating "A" 15.1 L/min (4 USgpm) Flow rating "B" 30.2 L/min (8 USgpm) Flow rating "C" 37.9 L/min (10 USgpm)
Hysteresis	1 USgpm with 400Hz PWM driver
Leakage (fully closed)	197 cm ³ /min (12 in ³ /min) at 3000 PSID
Ambient operating temperature	-30° to 90°C (-22° to 194°F)
Maximum oil temperature	120°C (248°F)
Maximum internal coil temperature	200°C (392°F)
Nominal supply voltage	12/24 V
Current to fully close valve	1500 - 1600 mA (12V coil), 750 - 800 mA (24V coil)
Recommended PWM frequency	200 - 400 Hz
Coil resistance at 20°C (68°F)	4.7 Ω (12V), 19.0 Ω (24V)
Mass	Cartridge only 0,37 kg (0.82 lb) Cartridge with coil and end nut 0,73 kg (1.62 lb)
Fluid	All general purpose hydraulic oils such as: MIL-H-5606, SAE 10, SAE 20, DTE 24, etc.
Filtration	Cleanliness code 18/16/13
Cavity	C-10-3
Seal kit	9900225-000 (Buna-N) 9900226-000 (Viton®)

Viton is a registered trademark of E.I. DuPont

Performance Curves

EFV1-10*-0
Cartridge Only

B

Max. Flow vs Pressure Drop
Flow rating "A" (Valve fully open)

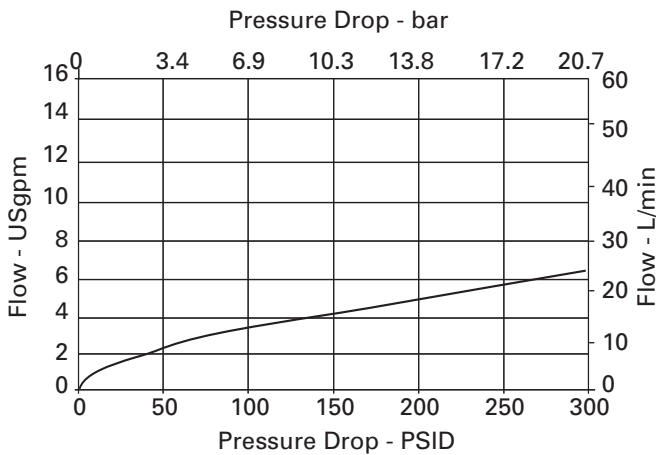

Max. Flow vs Pressure Drop
Flow rating "B" (Valve fully open)

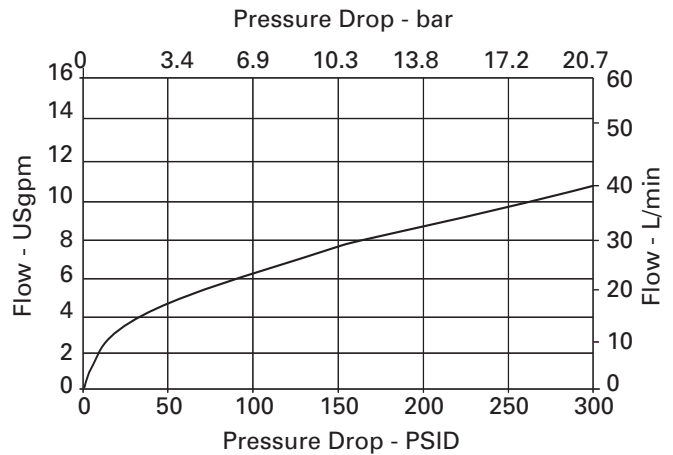

Max. Flow vs Pressure Drop
Flow rating "C" (Valve fully open)

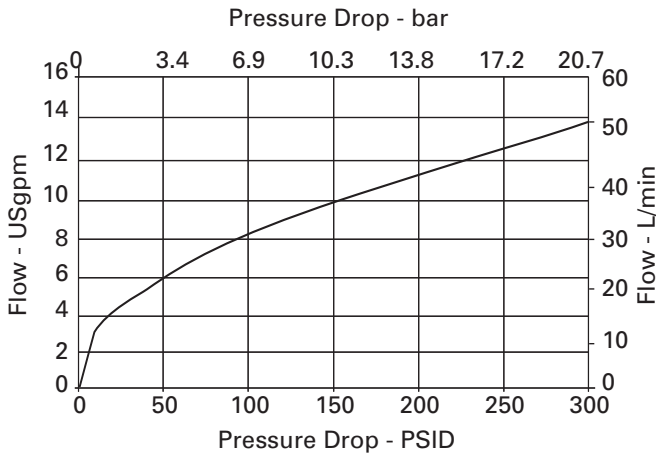

Flow vs. Current

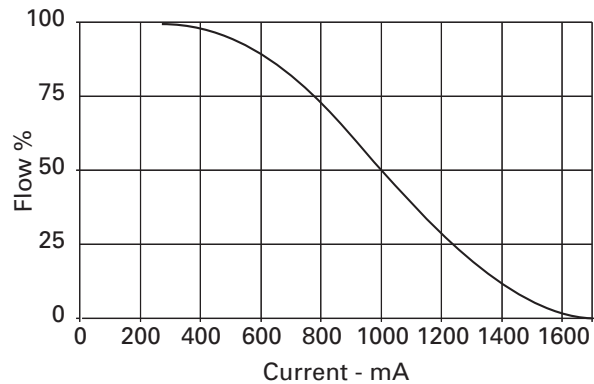

Note

To determine operating characteristics for the flow rating selected, at a specific differential pressure, first determine maximum flow from upper curve at the differential pressure value. This will be the "100% flow" flow on the lower curve.

Parameters: 400 Hz PWM

EFV1 - 10 * - 0 * * - * * * - * * * * E * * - 00

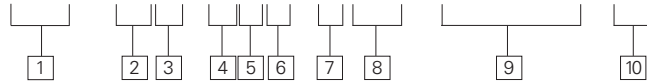

1 Function

EFV1 - Electro Proportional Flow Control Valve

2 Size

10 - 10 Size

3 Seals

N - Buna-N
V - Viton

4 Logic

0 - Normally Open

5 Flow Rating

A - 4 USgpm @ 160 PSID
B - 8 USgpm @ 160 PSID
C - 10 USgpm @ 160 PSID

6 Bleed Screw and Manual Override

0 - No core tube special features
S - Screw-in type manual override

7 8

Material Code Port Code*

		Description	Part Number
0	000	No manifold block	-
A	03B	Aluminum, Light Duty 3/8" BSPP	02-173358
	06T	Aluminum, Light Duty SAE 6	566162
	02G	Aluminum, 1/4" BSPP	876705
	03G	Aluminum, 3/8" BSPP	876714
	06H	Aluminum, SAE 6	876704
S	08H	Aluminum, SAE 8	876711
	02G	Steel, 1/4" BSPP	02-175127
	03G	Steel, 3/8" BSPP	02-175128
	06T	Steel, SAE 6	02-175124
	08T	Steel, SAE 8	02-175125

Note: Both the manifold and port plug are required.

9 Coil Model Code*

E-Series Coils See Section C.

* These model digits will not be stamped on the valve.

10 Special Features

00 - None
(Only required when valve has special features, omitted if "00.")

Dimensions

mm (inch)

Torque cartridge in housing

S - 68-75 Nm
(50-55 ft. lbs)
A - 47-54 Nm
(35-40 ft. lbs)

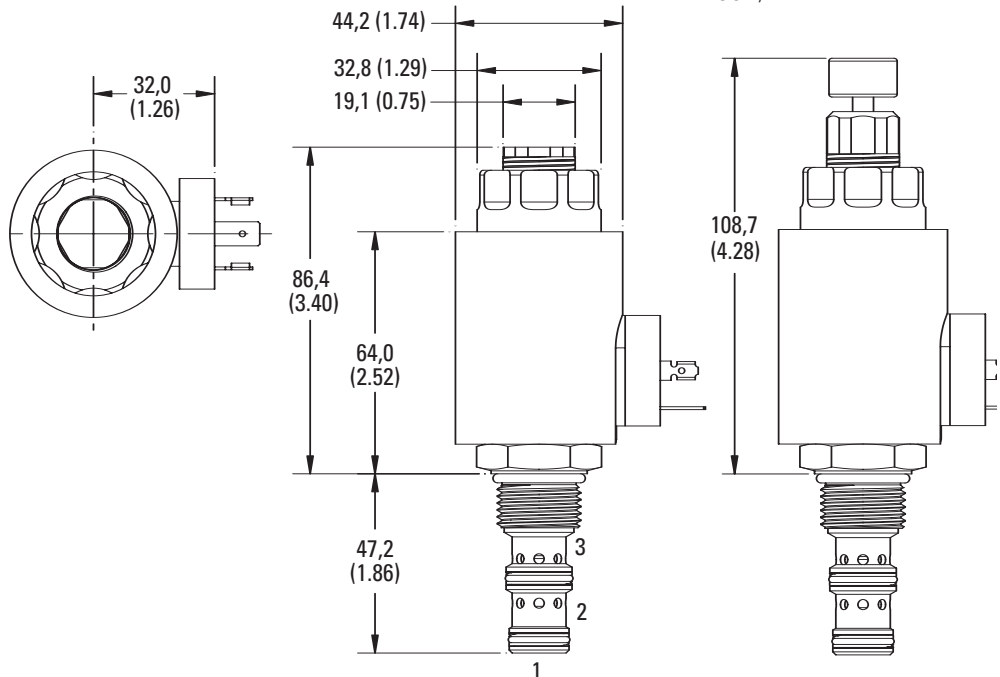

Note: EFV1-10 with DIN-43650 connector shown.

Note: Port 1 is unused and must be plugged.

Note - S type manual override shown

EFV1-10*-C

Proportional flow control valve, normally closed, spool type

Description

The EFV1-10*-C** is a normally closed, unidirectional, uncompensated, spool type, two way, proportional flow control, screw-in cartridge valve.

Operation

The valve is controlled by current supplied to the coil. At zero current, the valve is fully closed from port 3 to port 2. At 1500 mA (12V coil) the valve is considered fully open. This is the maximum intended current level for use in applications. Port 1 is used for pressure balancing the spool and armature and must be blocked in all cases.

The maximum intended pressure drop is 300 PSID. At pressure drops above 300 PSID, almost no increase in flow is obtained. The intended flow direction is from port 3 to port 2. Operation of the valve with flow from port 2 to port 3 will produce flow vs current and flow vs pressure drop curves that are significantly

different from those obtained with flow from port 3 to port 2. Since the spool and armature are pressure balanced, the operating pressure does not affect the operating characteristics of the valve. The operating point of the valve is determined only by current, pressure drop and temperature.

Functional Symbol

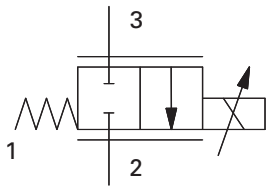

Profile View

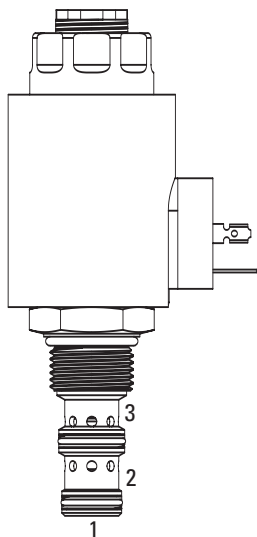

Note
Port 1 is unused and must be plugged.

RATINGS AND SPECIFICATIONS

Performance data is typical with DTE 24 hydraulic fluid at 120°F

Typical application pressure	210 bar (3000 psi)
Cartridge endurance rating	1 million cycles
Cartridge fatigue pressure rating (NFPA/T2.6.1 R2-2000)	210 bar (3000 psi)
Rated maximum flow at 160 PSID	Flow rating "A" 15.1 L/min (4 USgpm) Flow rating "B" 30.2 L/min (8 USgpm) Flow rating "C" 37.9 L/min (10 USgpm)
Hysteresis	1 USgpm with 400Hz PWM driver
Leakage (fully closed)	197 cm ³ /min (12 in ³ /min) at 3000 PSID
Ambient operating temperature	-30° to 90°C (-22° to 194°F)
Maximum oil temperature	120°C (248°F)
Maximum internal coil temperature	200°C (392°F)
Nominal supply voltage	12/24 V
Current to fully close valve	1500 - 1600 mA (12V coil), 750 - 800 mA (24V coil)
Recommended PWM frequency	200 - 400 Hz
Coil resistance at 20°C (68°F)	4.7 Ω (12V), 19.0 Ω (24V)
Mass	Cartridge only 0,37 kg (0.82 lb) Cartridge with coil and end nut 0,73 kg (1.62 lb)
Fluid	All general purpose hydraulic oils such as: MIL-H-5606, SAE 10, SAE 20, DTE 24, etc.
Filtration	Cleanliness code 18/16/13
Cavity	C-10-3
Seal kit	9900225-000 (Buna-N) 9900226-000 (Viton®)

Viton is a registered trademark of E.I. DuPont

Performance Curves

EFV1-10*-C
Cartridge Only

Max. Flow vs Pressure Drop
Flow rating "A" (Zero Current)

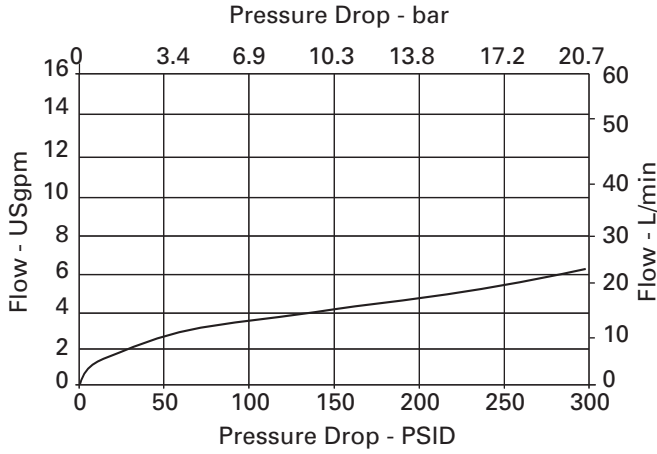

Max. Flow vs Pressure Drop
Flow rating "B" (Zero Current)

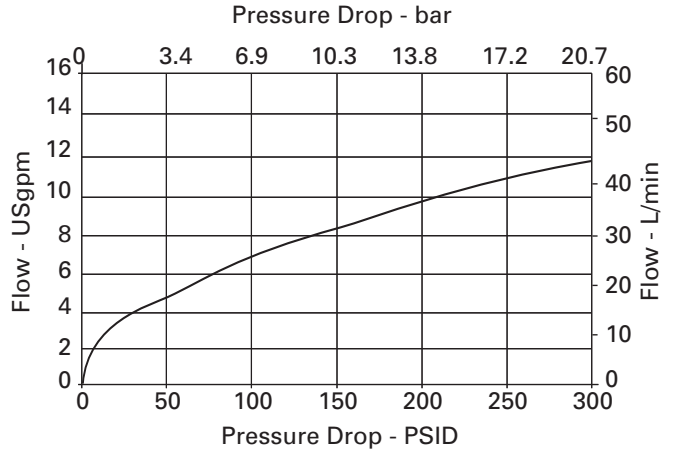

Max. Flow vs Pressure Drop
Flow rating "C" (Zero Current)

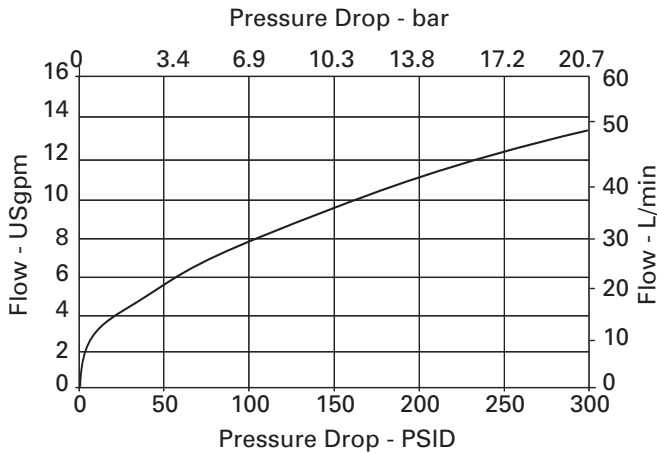

Flow vs. Current

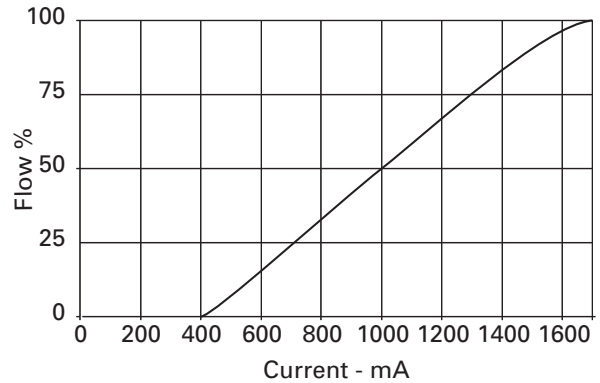

Note

To determine operating characteristics for the flow rating selected, at a specific differential pressure, first determine maximum flow from upper curve at the differential pressure value. This will be the "100%" flow on the lower curve.

Parameters: 400 Hz PWM

EFV1 - 10 * - C * * - * * * * - * * * * E * * - 00

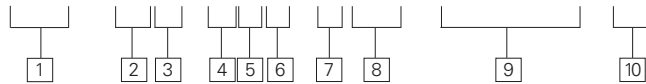

1 Function
EFV1 - Electro Proportional Flow Control Valve

2 Size
10 - 10 Size

3 Seals
N - Buna-N
V - Viton

4 Logic
C - Normally Closed

5 Flow Rating
A - 4 USgpm @ 160 PSID
B - 8 USgpm @ 160 PSID
C - 10 USgpm @ 160 PSID

6 Bleed Screw and Manual Override
0 - No core tube special features
S - Screw-in type manual override

Material Code	Port Code*	Description	Part Number
0	000	No manifold block	-
A	03B	Aluminum, Light Duty 3/8" BSPP	02-173358
	06T	Aluminum, Light Duty SAE 6	566162
	02G	Aluminum, 1/4" BSPP	876705
	03G	Aluminum, 3/8" BSPP	876714
S	06H	Aluminum, SAE 6	876704
	08H	Aluminum, SAE 8	876711
	02G	Steel, 1/4" BSPP	02-175127
	03G	Steel, 3/8" BSPP	02-175128
	06T	Steel, SAE 6	02-175124
	08T	Steel, SAE 8	02-175125

Note: Both the manifold and port plug are required.

9 Coil Model Code*

E-Series Coils See Section C.
 * These model digits will not be stamped on the valve.

10 Special Features

00 - None
 (Only required when valve has special features, omitted if "00.")

Dimensions

mm (inch)

Torque cartridge in housing

- S** - 68-75 Nm (50-55 ft. lbs)
- A** - 47-54 Nm (35-40 ft. lbs)

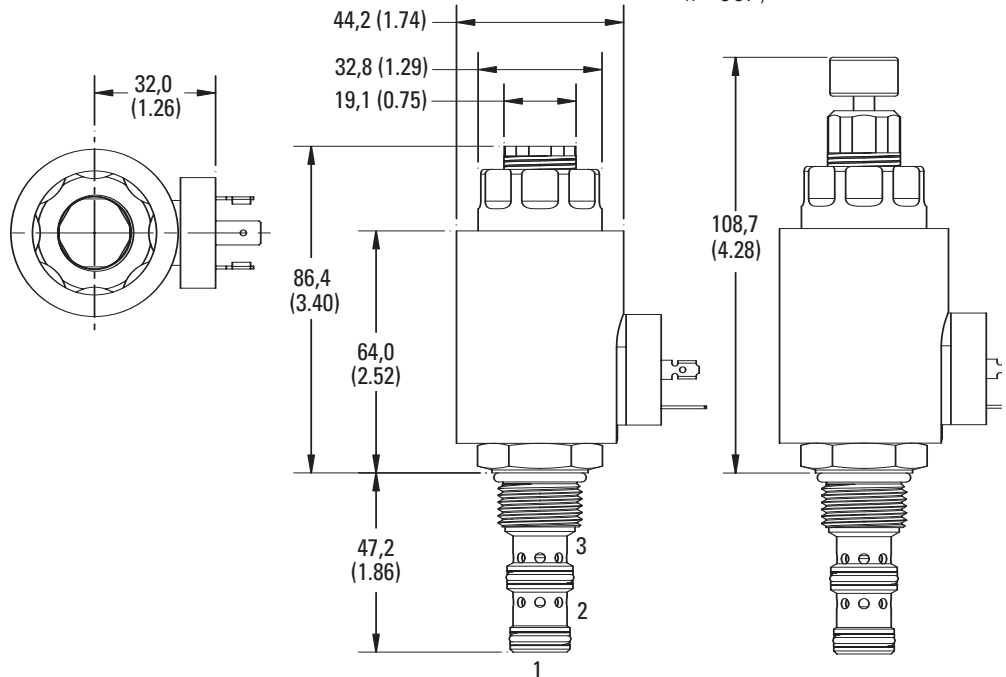

Note: EFV1-10 with DIN-43650 connector shown.

Note: Port 1 is unused and must be plugged.

Note - S type manual override shown.

EFV1-12*-0

Proportional flow control valve, normally open, spool type

Description

The EFV1-12*-0** is a normally open, unidirectional, uncompensated, spool type, two way, proportional flow control, screw-in cartridge valve.

Operation

The valve is controlled by current supplied to the coil. At zero current, the valve is fully open from port 2 to port 3. At 1500 to 1600 mA (12V coil) the valve is fully closed. Port 1 is used for pressure balancing the spool and armature and must be blocked in all cases.

The maximum intended pressure drop is 300 PSID.

At pressure drops above 300 PSID, almost no increase in flow is obtained. The intended flow direction is from port 2 to port 3. Operation of the valve with flow from port 3 to port 2 will produce flow vs current and flow vs pressure drop curves that are significantly different from those obtained with flow from port 2 to port 3.

Since the spool and armature are pressure balanced, the operating pressure does not affect the operating characteristics of the valve. The operating point of the valve is determined only by current, pressure drop and temperature.

Functional Symbol

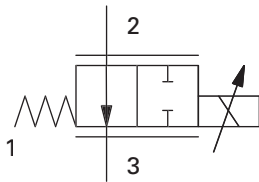

Profile View

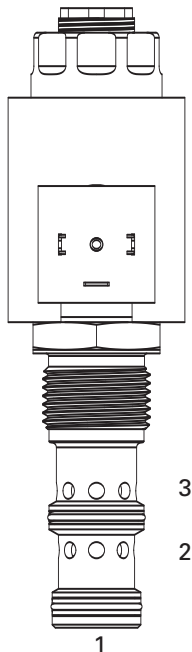

RATINGS AND SPECIFICATIONS

Performance data is typical with DTE 24 hydraulic fluid at 120°F

Typical application pressure	210 bar (3000 psi)
Cartridge endurance rating	1 million cycles
Cartridge fatigue pressure rating (NFPA/T2.6.1 R2-2000)	210 bar (3000 psi)
Rated maximum flow at 300 PSID	Flow rating "A" 95 L/min (25.0 USgpm) Flow rating "B" 104 L/min (27.5 USgpm)
Hysteresis	1 USgpm with 400Hz PWM driver
Leakage (fully closed)	77 - 483 cm ³ /min (5 - 30 in ³ /min) at 3000 PSID
Ambient operating temperature	-30° to 90°C (-22° to 194°F)
Maximum oil temperature	120°C (248°F)
Maximum internal coil temperature	200°C (392°F)
Nominal supply voltage	12/24 V
Current to fully close valve	1500 - 1600 mA (12V coil), 750 - 800 mA (24V coil)
Recommended PWM frequency	200 - 400 Hz
Coil resistance at 20°C (68°F)	4.7 Ω (12V), 19.0 Ω (24V)
Mass	Cartridge only 0,37 kg (0.82 lb) Cartridge with coil and end nut 0,73 kg (1.62 lb)
Fluid	All general purpose hydraulic oils such as: MIL-H-5606, SAE 10, SAE 20, DTE 24, etc.
Filtration	Cleanliness code 18/16/13
Cavity	C-12-3
Seal kit	9900171-000 (Buna-N) 9900172-000 (Viton®)

Viton is a registered trademark of E.I. DuPont

Note

Port 1 is unused and must be plugged.

Performance Curves

EFV1-12*-0

Cartridge Only

B

Max. Flow vs Pressure Drop

Flow rating "A" (Zero Current)

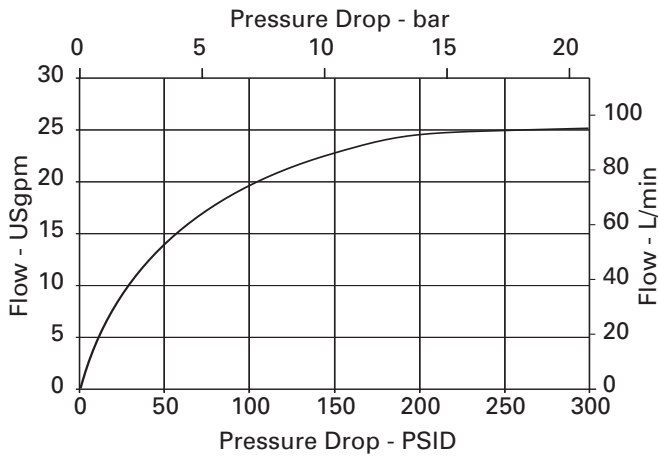

Max. Flow vs Pressure Drop

Flow rating "B" (Zero Current)

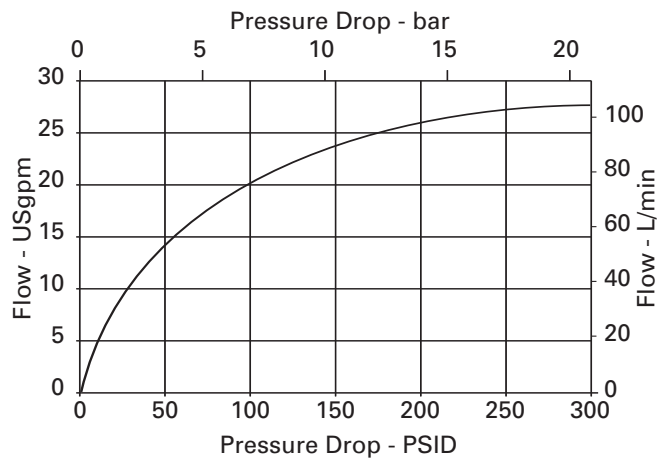

Flow vs Current

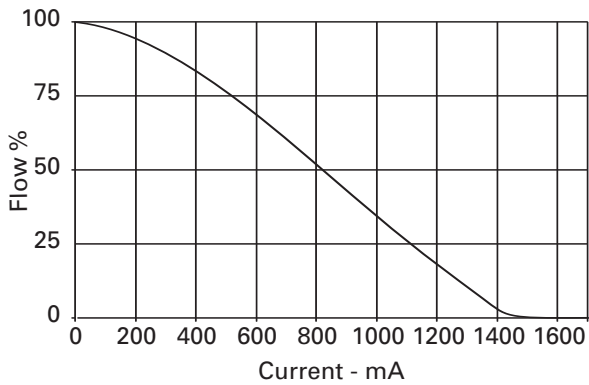

Note

To determine operating characteristics for the flow rating selected, at a specific differential pressure, first determine maximum flow from upper curve at the differential pressure value. This will be the "100% flow" flow on the lower curve.

Parameters:
400 Hz PWM

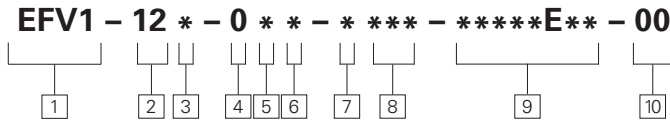

1 Function
EFV1 - Electro Proportional Flow Control Valve

5 Flow Rating
A - 25.0 USgpm @ 300 PSID
B - 27.5 USgpm @ 300 PSID

7 Material Code **8 Port Code***

2 Size
12 - 12 Size

6 Bleed Screw and Manual Override
0 - No core tube special features
S - Screw-in type manual override

		Description	Part Number
0	000	No manifold block	—
A	04G	Aluminum, 1/2" BSPP	02-161817
	06G	Aluminum, 3/4" BSPP	02-161816
	10T	Aluminum, SAE 10	02-160642
S	12T	Aluminum, SAE 12	02-160646
	04G	Steel, 1/2" BSPP	02-169815
	06G	Steel, 3/4" BSPP	02-169814
	10T	Steel, SAE 10	02-161070
	12T	Steel, SAE 12	02-169816

3 Seals
N - Buna-N
V - Viton®

4 Logic
0 - Normally Open

Note: Both the manifold and port plug are required.

9 Coil Model Code*
 E-Series Coils See Section C.

10 Special Features
00 - None
 (Only required when valve has special features, omitted if "00.")

* These model digits will not be stamped on the valve.

Dimensions

mm (inch)

Torque cartridge in housing

- S** - 136-149 Nm (100-110 ft. lbs)
- A** - 108-122 Nm (80-90 ft. lbs)

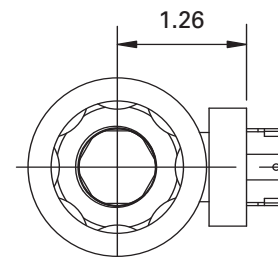
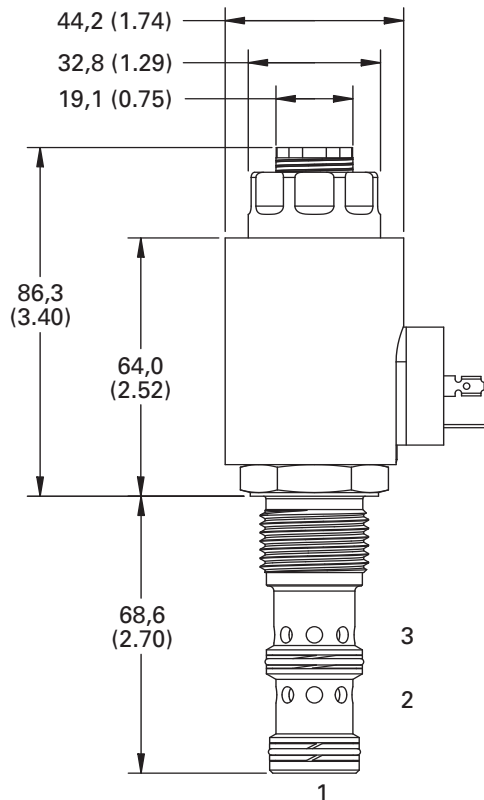

Note
 EFV1-12 with DIN-43650 connector shown.

Note
 Port 1 is unused and must be plugged.

EFV1-12*-C

Proportional flow control valve, normally closed, spool type

Description

The EFV1-12*-C** is a normally closed, unidirectional, uncompensated, spool type, two way, proportional flow control, screw-in cartridge valve.

Operation

The valve is controlled by current supplied to the coil. At zero current, the valve is fully closed from port 3 to port 2. At 1500 mA (12V coil) the valve is considered fully open. This is the maximum intended current level for use in applications. Port 1 is used for pressure balancing the spool and armature and must be blocked in all cases.

The maximum intended pressure drop is 300 PSID. At pressure drops above 300 PSID, almost no increase in flow is obtained. The intended flow direction is from port 3 to port 2. Operation of the valve with flow from port 2 to port 3 will produce flow vs current and flow vs pressure drop curves that are significantly different from those

obtained with flow from port 3 to port 2.

Since the spool and armature are pressure balanced, the operating pressure does not affect the operating characteristics of the valve. The operating point of the valve is determined only by current, pressure drop and temperature.

Functional Symbol

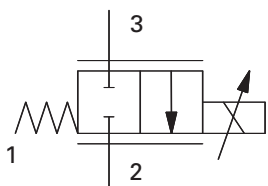

Profile View

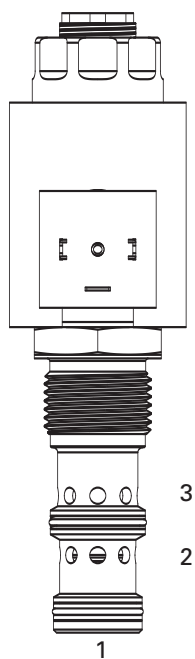

Note

Port 1 is unused and must be plugged.

RATINGS AND SPECIFICATIONS

Performance data is typical with DTE 24 hydraulic fluid at 120°F

Typical application pressure	210 bar (3000 psi)
Cartridge endurance rating	1 million cycles
Cartridge fatigue pressure rating (NFPA/T2.6.1 R2-2000)	210 bar (3000 psi)
Rated maximum flow at 300 PSID	Flow rating "A" 55L/min (14.3 USgpm) Flow rating "B" 77 L/min (20.6 USgpm)
Hysteresis	1 USgpm with 400Hz PWM driver
Leakage (fully closed)	77 - 483 cm ³ /min (5 - 30 in ³ /min) at 3000 PSID
Ambient operating temperature	-30° to 90°C (-22° to 194°F)
Maximum oil temperature	120°C (248°F)
Maximum internal coil temperature	200°C (392°F)
Nominal supply voltage	12/24 V
Current to fully close valve	1500 - 1600 mA (12V coil), 750 - 800 mA (24V coil)
Recommended dither frequency	200 - 400 Hz
Coil resistance at 20°C (68°F)	4.7 Ω (12V), 19.0 Ω (24V)
Mass	Cartridge only 0,37 kg (0.82 lb) Cartridge with coil and end nut 0,73 kg (1.62 lb)
Fluid	All general purpose hydraulic oils such as: MIL-H-5606, SAE 10, SAE 20, DTE 24, etc.
Filtration	Cleanliness code 18/16/13
Cavity	C-12-3
Seal kit	9900171-000 (Buna-N) 9900172-000 (Viton®)

Viton is a registered trademark of E.I. DuPont

Performance Curves

EFV1-12*-C

Cartridge Only

Max. Flow vs Pressure Drop

Flow rating "A" (Valve fully open)

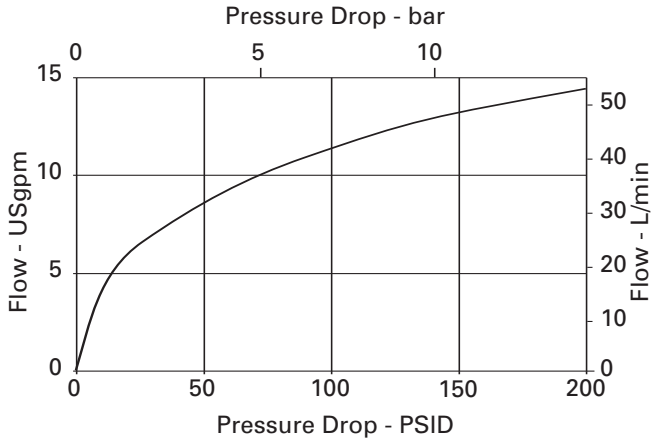

Max. Flow vs Pressure Drop

Flow rating "B" (Valve fully open)

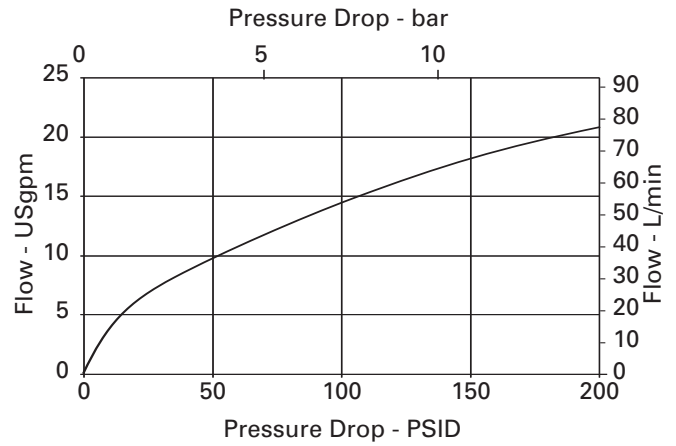

Flow vs Current

(Flow rating "B")

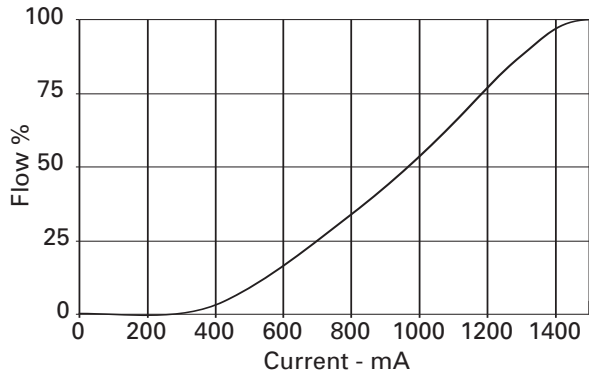

Note

To determine operating characteristics for the flow rating selected, at a specific differential pressure, first determine maximum flow from upper curve at the differential pressure value. This will be the "100%" flow on the lower curve.

Parameters:
400 Hz PWM

EFV1 - 12 * - C * * - * * * * - * * * * E * * - 00

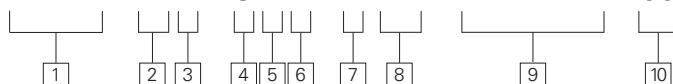

1 Function
EFV1 - Electro Proportional Flow Control Valve

5 Flow Rating
A - 14.3 USgpm @ 300 PSID
B - 20.6 USgpm @ 300 PSID

7 Material Code **8 Port Code***

2 Size
12 - 12 Size

6 Bleed Screw and Manual Override
0 - No core tube special features
S - Screw-in type manual override

		Description	Part Number
0	000	No manifold block	N/A
A	04G	Aluminum, 1/2" BSPP	02-161817
	06G	Aluminum, 3/4" BSPP	02-161816
	10T	Aluminum, SAE 10	02-160642
S	12T	Aluminum, SAE 12	02-160646
	04G	Steel, 1/2" BSPP	02-169815
	06G	Steel, 3/4" BSPP	02-169814
	10T	Steel, SAE 10	02-161070
	12T	Steel, SAE 12	02-169816

3 Seals
N - Buna-N
V - Viton®

Note: Both the manifold and port plug are required.

4 Logic
C - Normally Closed

9 Coil Model Code*
 E-Series Coils See Section C.

10 Special Features
00 - None

* These model digits will not be stamped on the valve.

(Only required when valve has special features, omitted if "00.")

Dimensions

mm (inch)

Torque cartridge in housing

S - 136-149 Nm (100-110 ft. lbs)
A - 108-122 Nm (80-90 ft. lbs)

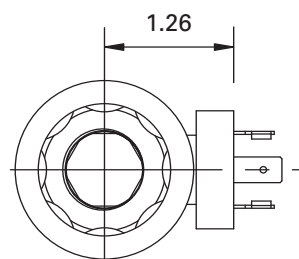
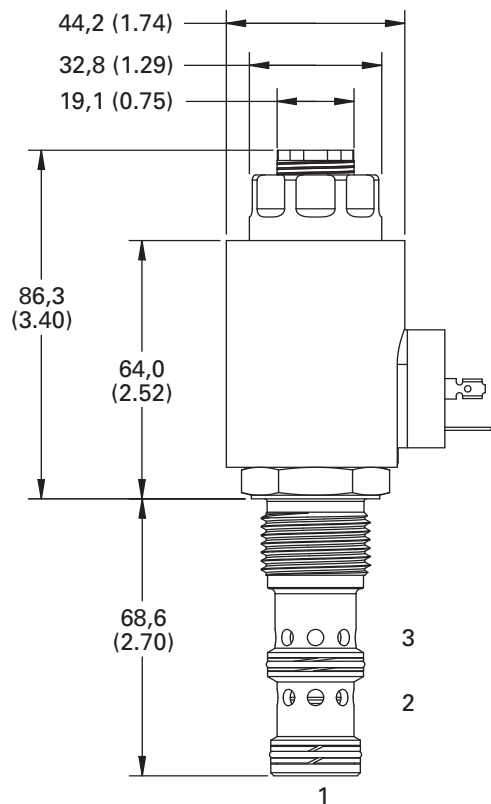

Note: EFV1-12 with DIN-43650 connector shown.

Note
 Port 1 is unused and must be plugged.

EFV2-12*-0

Proportional flow control valve, normally open, pressure compensated, spool type

Description

The EFV2-12*-0 is a normally open, three port, pressure compensated, proportional flow control valve. The valve can be used as a priority flow regulator, with regulated flow being supplied to port 3 and excess flow being by-

passed to port 2. If port 2 is blocked the valve functions as a restrictive, 2 way, pressure compensated flow regulator.

Operation

Current supplied to the coil controls the valve. At zero current, the valve is fully open from port 1 to port 3. At 1600 mA (12V coil) the valve is fully closed. The valve will regulate flow out of port 3 regardless of

downstream system pressure. As current is increased to the solenoid the flow out of port 3 will decrease.

Functional Symbol

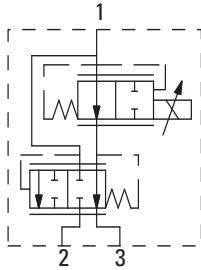

Sectional View

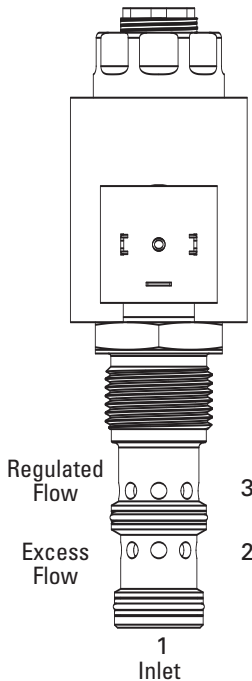

RATINGS AND SPECIFICATIONS

Performance data is typical with DTE 24 hydraulic fluid at 120°F

Typical application pressure	210 bar (3000 psi)
Cartridge endurance rating	1 million cycles
Cartridge fatigue pressure rating (NFPA/T2.6.1 R2-2000)	210 bar (3000 psi)
Rated Flow	<p>"A" Spool – Max. Regulated flow (By-Pass Mode): 53L/min (14.0 USgpm) Max. Regulated flow (2 Port Mode): 42L/min (11.0 USgpm) Max. Input flow: 114L/min (30.0 USgpm)</p> <p>"B" Spool – Max. Regulated flow (By-Pass Mode): 38L/min (10.0 USgpm) Max. Regulated flow (2 Port Mode): 31L/min (8.0 USgpm) Max. Input flow: 114L/min (30.0 USgpm)</p> <p>Note: Max Regulated Flow may decrease slightly during compensation.</p>
Hysteresis	1.5 USgpm max with 400Hz PWM driver
Leakage (fully closed)	240 cm ³ /min (15 in ³ /min) at 3000 PSID
Ambient operating temperature	-30° to 90°C (-22° to 194°F)
Maximum oil temperature	120°C (248°F)
Maximum internal coil temperature	200°C (392°F)
Nominal supply voltage	12/24 V
Current to fully open valve	350 ± 100mA (12V coil), 175 ± 50 mA (24V coil)
Current to fully close valve	1600 ± 200 mA (12V coil), 800 ± 100 mA (24V coil)
Recommended PWM frequency	200 - 400 Hz
Coil resistance at 20°C (68°F)	4.7 Ω (12V), 19.0 Ω (24V)
Mass	Cartridge only 0,37 kg (0.82 lb) Cartridge with coil and end nut 0,73 kg (1.62 lb)
Fluid	All general purpose hydraulic oils such as: MIL-H-5606, SAE 10, SAE 20, DTE 24, etc.
Filtration	Cleanliness code 18/16/13
Cavity	C-12-3
Seal kit	9900171-000 (Buna-N) 9900172-000 (Viton®)

Viton is a registered trademark of E.I. DuPont

Performance Curves

EFV2-12*-0

Cartridge Only

B

Pressure Drop Port 1 to Port 2

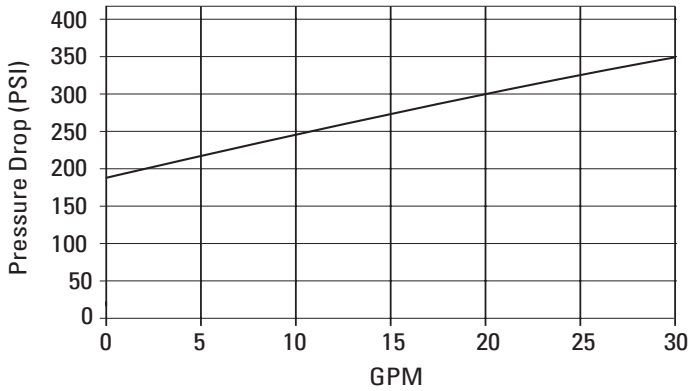

Pressure Drop Port 1 to Port 3

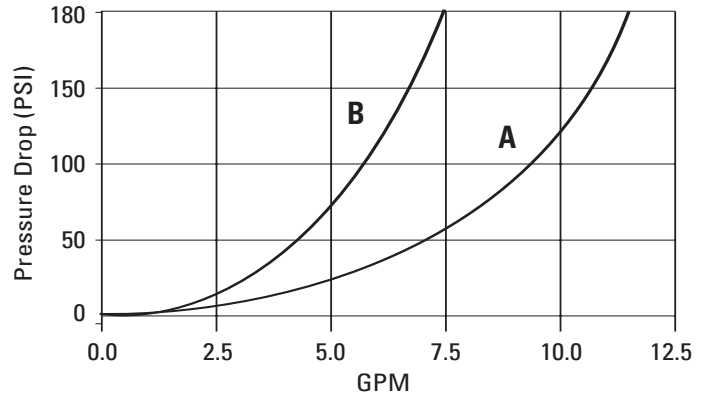

Flow vs Current - A Spool

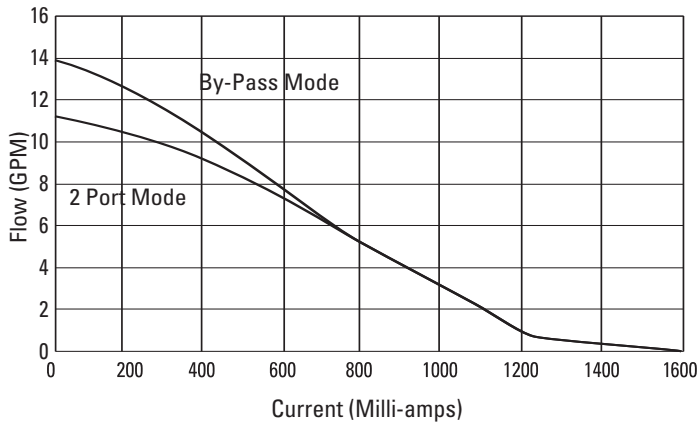

Flow vs Current - B Spool

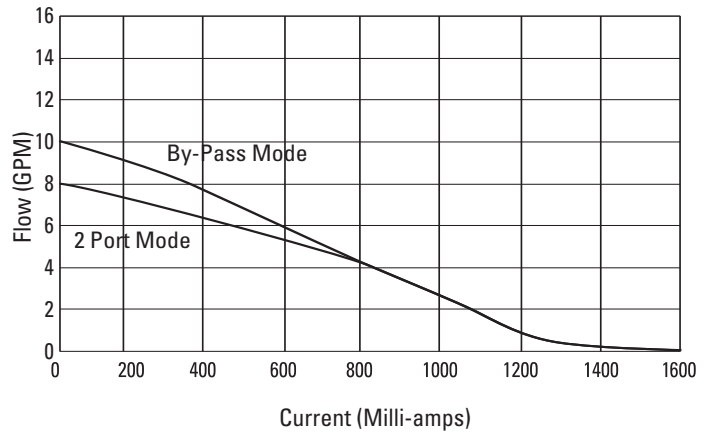

Parameters:
400 Hz PWM

Regulated Flow vs Pressure

Port 3 Pressure > Port 2 Pressure

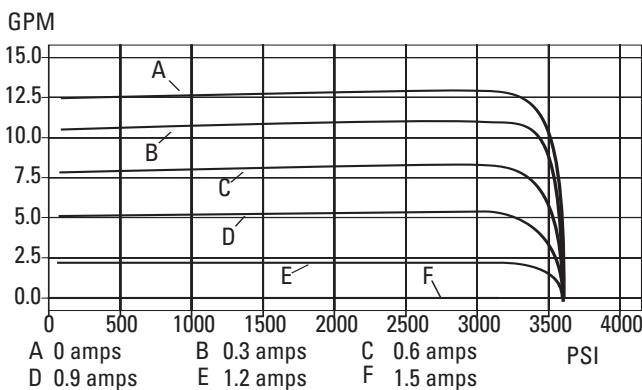

Regulated Flow vs Pressure

Port 2 Pressure > Port 3 Pressure

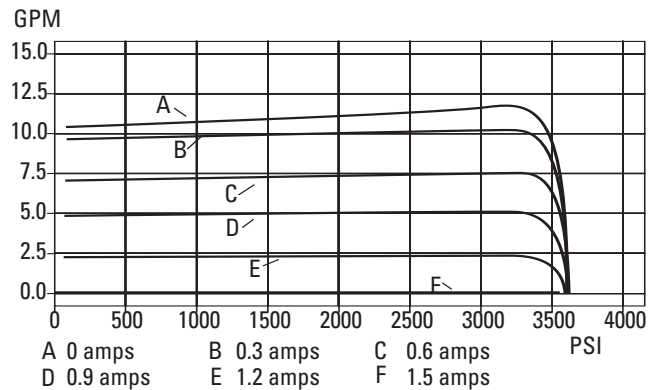

Note: Pressure Compensation curves are shown for "B" spool valves.

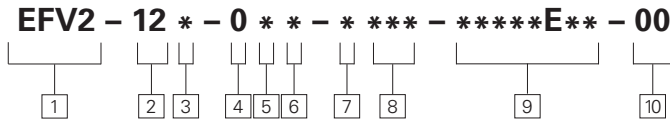

1 Function
EFV2 - Electro Proportional Flow Control Valve

2 Size
12 - 12 Size

3 Seals
N - Buna-N
V - Viton®

4 Logic
0 - Normally Open

5 Flow Rating
A - 14 USgpm @ 180 PSID
B - 10 USgpm @ 180 PSID
 See specifications

6 Bleed Screw and Manual Override
0 - No core tube special features
S - Screw-in type manual override

7 Material Code	8 Port Code*	Description	Part Number
0	000	No manifold block	-
A	04G	Aluminum, 1/2" BSPP	02-161817
	06G	Aluminum, 3/4" BSPP	02-161816
	10T	Aluminum, SAE 10	02-160642
S	12T	Aluminum, SAE 12	02-160646
	04G	Steel, 1/2" BSPP	02-169815
	06G	Steel, 3/4" BSPP	02-169814
10T	10T	Steel, SAE 10	02-161070
	12T	Steel, SAE 12	02-169816

Note: Both the manifold and port plug are required.

9 Coil Model Code*
 E-Series Coils See Section C.

* These model digits will not be stamped on the valve.

10 Special Features
00 - None
 (Only required when valve has special features, omitted if "00.")

Dimensions

mm (inch)

Torque cartridge in housing

- S** - 136-149 Nm (100-110 ft. lbs)
- A** - 108-122 Nm (80-90 ft. lbs)

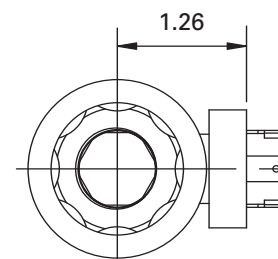
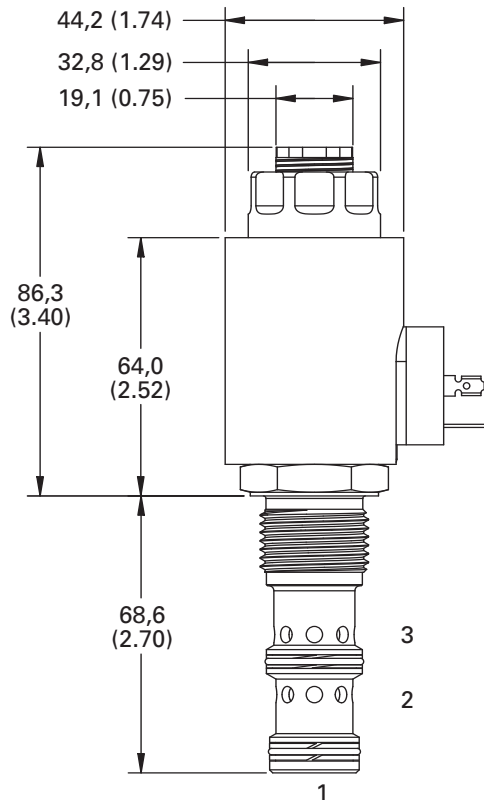

Note
 EFV2-12 with DIN-43650 connector shown.

EFV2-12*-C

Proportional flow control valve, normally closed, spool type

Description

The EFV2-12*-C is a normally closed, three port, pressure compensated, proportional flow control valve. The valve can be used as a priority flow regulator, with regulated flow being supplied to port 3 and excess flow being by-passed to port 2.

If port 2 is blocked the valve functions as a restrictive, 2 way, pressure compensated flow regulator.

Operation

Current supplied to the coil controls the valve. At zero current, the valve is fully closed from port 1 to port 3. At 1500 to 1600 mA (12V coil) the valve is fully open.

The valve will regulate flow out of port 3 regardless of downstream system pressure. As current is increased to the solenoid the flow out of port 3 will increase.

Functional Symbol

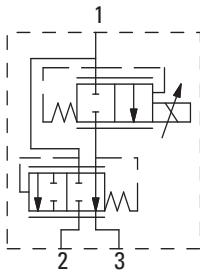

Profile View

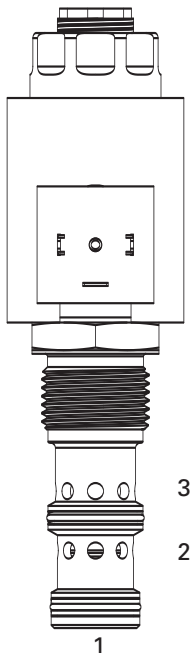

RATINGS AND SPECIFICATIONS

Performance data is typical with DTE 24 hydraulic fluid at 120°F

Typical application pressure	210 bar (3000 psi)
Cartridge endurance rating	1 million cycles
Cartridge fatigue pressure rating (NFPA/T2.6.1 R2-2000)	210 bar (3000 psi)
Rated Flow	"A" Spool – Max. Regulated flow (By-Pass Mode): 57L/min (15.0 USgpm) Max. Regulated flow (2 Port Mode): 53L/min (14.0 USgpm) Max. Input flow: 114L/min (30.0 USgpm) "B" Spool – Max. Regulated flow (By-Pass Mode): 38L/min (10.0 USgpm) Max. Regulated flow (2 Port Mode): 31L/min (8.0 USgpm) Max. Input flow: 114L/min (30.0 USgpm)

Note: Max Regulated Flow may decrease slightly during compensation.

Hysteresis	1.5 USgpm max with 400Hz PWM driver
Leakage (fully closed)	240 cm ³ /min (15 in ³ /min) at 3000 PSID
Ambient operating temperature	-30° to 90°C (-22° to 194°F)
Maximum oil temperature	120°C (248°F)
Maximum internal coil temperature	200°C (392°F)
Nominal supply voltage	12/24 V
Current to fully open valve	1600 ± 200 mA (12V coil), 800 ± 100 mA (24V coil)
Current to fully close valve	350 ± 100 mA (12V coil), 175 ± 50 mA (24V coil)
Recommended dither frequency	200 - 400 Hz
Coil resistance at 20°C (68°F)	4.7 Ω (12V), 19.0 Ω (24V)
Mass	Cartridge only 0,37 kg (0.82 lb) Cartridge with coil and end nut 0,73 kg (1.62 lb)
Fluid	All general purpose hydraulic oils such as: MIL-H-5606, SAE 10, SAE 20, DTE 24, etc.
Filtration	Cleanliness code 18/16/13
Cavity	C-12-3
Seal kit	9900171-000 (Buna-N) 9900172-000 (Viton®)

Viton is a registered trademark of E.I. DuPont

Performance Curves

EFV2-12*-C

Cartridge Only

Flow vs Pressure Drop

Excess flow P1 to P2 (P3 to Atm)
Full current (1700 mA on a 12V Coil)

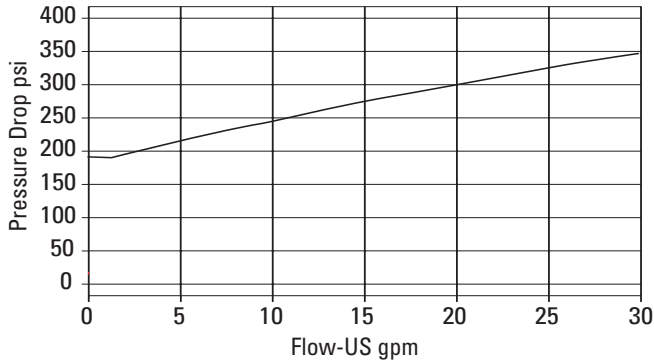

Flow vs Pressure Drop

Regulated flow P1 to P3 (P2 to Atm)
Full current (1700 mA on a 12V Coil)

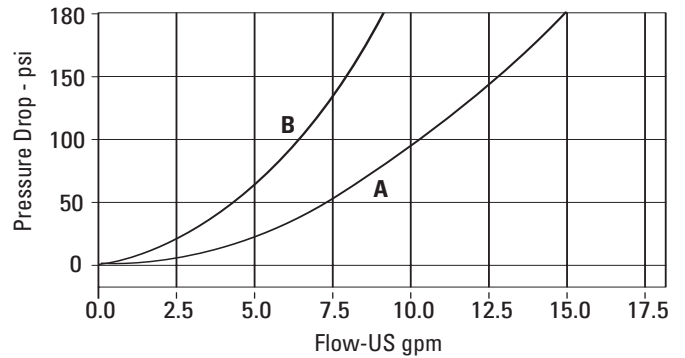

A - A spool pressure drop
B - B spool pressure drop

Flow vs Current

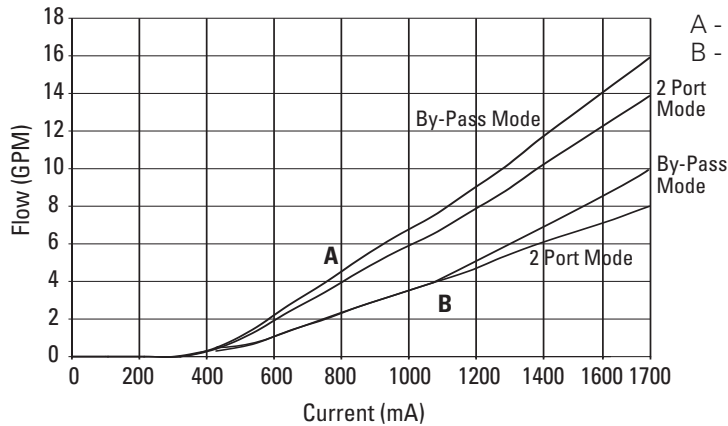

A - A spool
B - B spool

Regulated Flow vs Pressure

Regular to Bypass

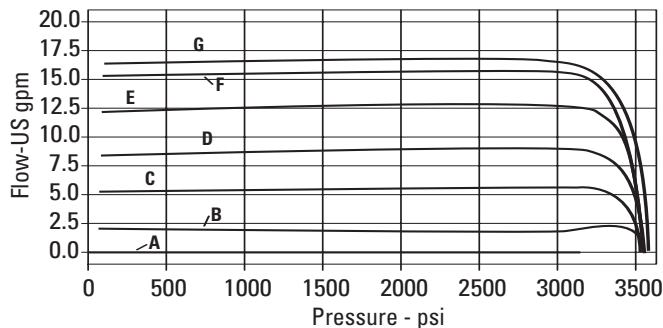

A - 0.3 AMPS B - 0.6 AMPS C - 0.9 AMPS
D - 1.2 AMPS E - 1.5 AMPS F - 1.8 AMPS
G - 2.0 AMPS

Regulated Flow vs Pressure

Bypass to Regular

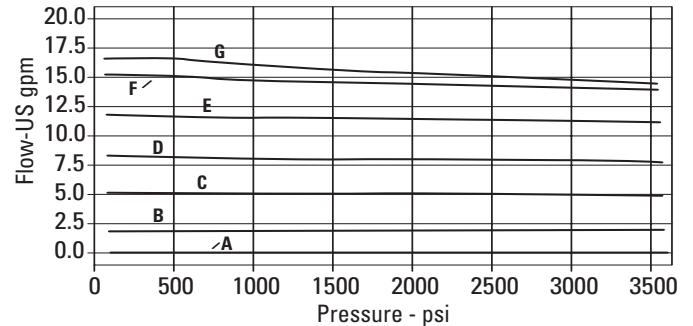

A - 0.3 AMPS B - 0.6 AMPS C - 0.9 AMPS
D - 1.2 AMPS E - 1.5 AMPS F - 1.8 AMPS
G - 2.0 AMPS

Note: Pressure Compensation curves are shown for "B" spool valves.

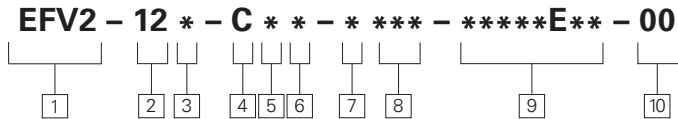

1 Function
EFV2 - Electro Proportional Flow Control Valve

2 Size
12 - 12 Size

3 Seals
N - Buna-N
V - Viton®

4 Logic
C - Normally Closed

5 Flow Rating
A - 15 USgpm @ 180 PSID
B - 10 USgpm @ 180 PSID
 See Specifications

6 Bleed Screw and Manual Override
0 - No core tube special features
S - Screw-in type manual override

7 Material Code	8 Port Code*	Description	Part Number
0	000	No manifold block	N/A
A	04G	Aluminum, 1/2" BSPP	02-161817
	06G	Aluminum, 3/4" BSPP	02-161816
	10T	Aluminum, SAE 10	02-160642
S	12T	Aluminum, SAE 12	02-160646
	04G	Steel, 1/2" BSPP	02-169815
	06G	Steel, 3/4" BSPP	02-169814
	10T	Steel, SAE 10	02-161070
	12T	Steel, SAE 12	02-169816

Note: Both the manifold and port plug are required.

9 Coil Model Code*
 See Section C.
 * These model digits will not be stamped on the valve.

10 Special Features
00 - None
 (Only required when valve has special features, omitted if "00.")

Dimensions
 mm (inch)
 Torque cartridge in housing
S - 136-149 Nm (100-110 ft. lbs)
A - 108-122 Nm (80-90 ft. lbs)

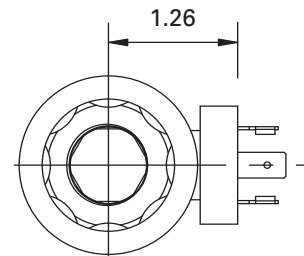
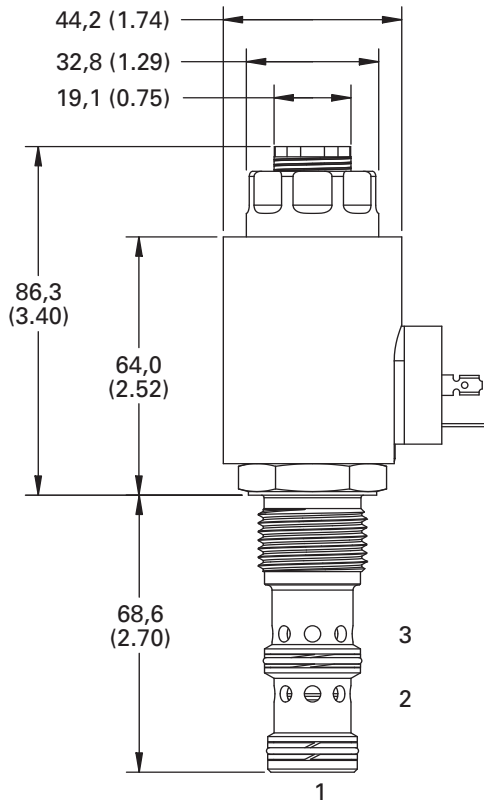

Note: EFV2-12 with DIN-43650 connector shown.

ERV2-10

Proportionally controlled pressure relief valve

Direct acting-low pressure, for pilot control applications

Description

The ERV2-10 is an electric, proportionally controlled, direct acting, spool type, screw-in relief valve.

Operation

This valve remains closed between port 1 and 2 until the predetermined pressure setting has been reached at port 1, overcoming the electrical force and unseating the spool to allow flow from port 2.

Functional Symbol

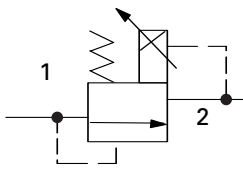

Sectional View

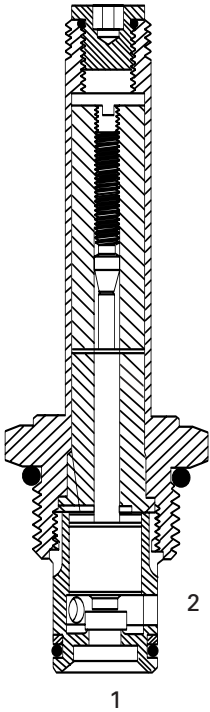

RATINGS AND SPECIFICATIONS

Performance data is typical with fluid at 21,8 cSt (105 SUS) and 49°C (120°F)

Typical application pressure (all ports)	0 - 35 bar (0 - 500 psi)
Cartridge fatigue pressure (infinite life)	35 bar (500 psi)
Rated flow	0,2 - 2,8 L/min (0.05 - 0.75 USgpm)
Cavity	C-10-2
Standard housing materials	Aluminum
Temperature range	-40° to 120°C (-40° to 248°F)
Fluids	All general purpose hydraulic fluids such as: MIL-H-5606, SAE 10, SAE 20, etc.
Filtration	Cleanliness code 18/16/13
Weight cartridge and coil	0,43 kg (0.95 lbs)
Seal kits	565810 (Buna-N) 889609 (Viton®)

Viton is a registered trademark of E.I. DuPont

Pressure Override Characteristics

Pressure override, energized

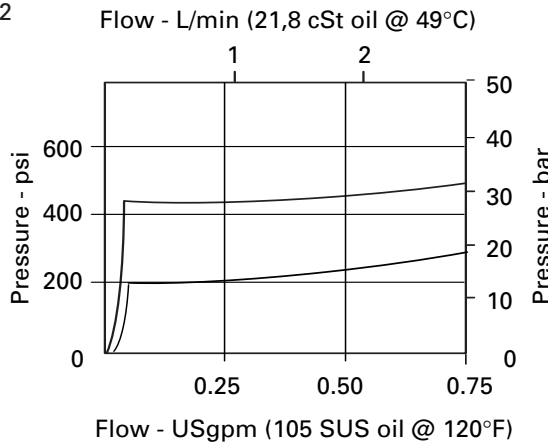

Pressure override, de-energized

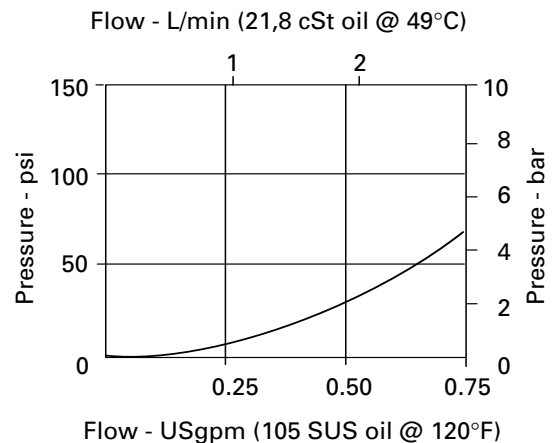

ERV2 - 10 (V) - ** - ** - * - * - 00**

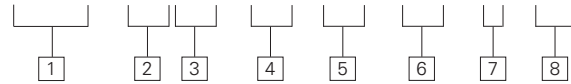

- 1 Function**
ERV2 - Proportional relief valve

- 2 Size**
10 - 10 Size

- 3 Seals**
Blank - Buna-N
V - Viton®

- 4 Maximum pressure (factory set)**
Customer to specify settings in increments of 7 bar (100 psi) and coded in hundreds of psi within the 0-35 bar range (0-500 psi) range.
Example: **5** - 35,0 (500 psi)

5 Port size
0 - Cartridge only

CODE	PORT SIZE	HOUSING NUMBER
6T	SAE 6	566151*
2G	1/4" BSPP	876702
3G	3/8" BSPP	876703
6H	SAE 6	876700
8H	SAE 8	876701

- 6 Voltage rating**
00 - No coil
12D - 12VDC
24D - 24VDC
12B - 12VDC/w diode*
24B - 24VDC/w diode*
*Optional arc suppressing diode.
Note: This valve uses the standard J series coils, see page section C for coil part numbers and specifications.

*Light duty housing.
See section J for housings.

- 7 Connector Types**
Blank - No coil
G - DIN 43650
Q - Spade terminals
W - Leadwire
N - Deutsch
Y - Amp JR
- 8 Special Features**
00 - None
(Only required when valve has special features, omitted if "00.")

WARNING
Maintain 5-8 Nm (4-6 ft. lbs) maximum torque on valve tube nut. Over tightening may cause valve failure.

Dimensions
mm (inch)
Torque cartridge in aluminum housing
47-54 Nm (35-40 ft. lbs)

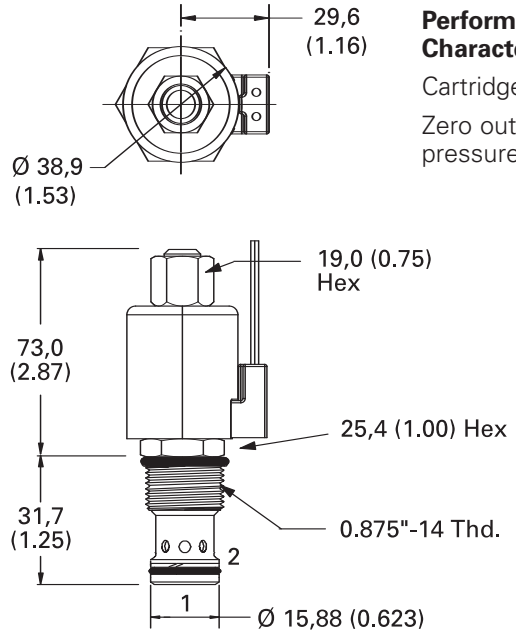

Valve is shown with "W" coil.

Performance Characteristics
Cartridges only
Zero outlet pressure

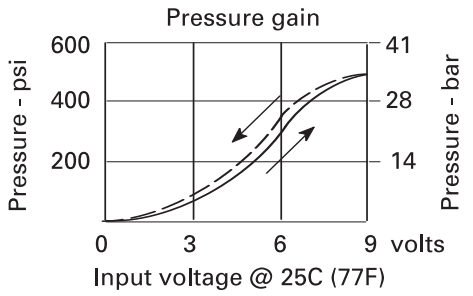
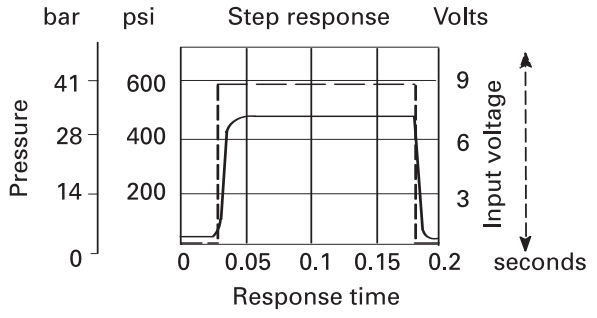

ERV3-10

Proportionally controlled pressure relief valve

Direct acting-high pressure, for pilot control applications

Description

The ERV3-10 is an electric, proportionally controlled, direct acting, spool type, screw-in relief valve.

Operation

This valve remains closed between port 1 and 2 until the predetermined pressure setting has been reached at port 1, overcoming the electrical force and unseating the spool to allow flow from port 2.

Functional Symbol

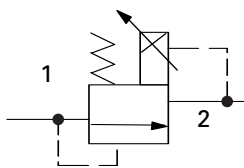

Sectional View

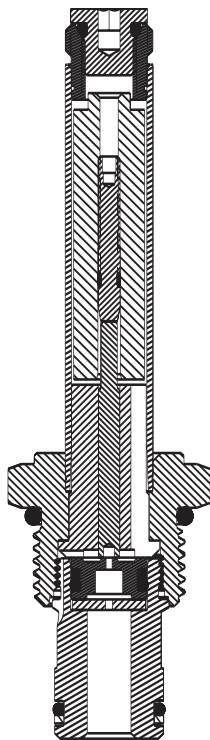

RATINGS AND SPECIFICATIONS

<i>Performance data is typical with fluid at 21,8 cSt (105 SUS) and 49°C (120°F)</i>	
Typical application pressure (all ports)	3000 psi (210 bar)
Cartridge fatigue pressure (infinite life)	3000 psi (210 bar)
Rated flow	0,8 L/min (0.20 USgpm)
Cavity	C-10-2
Standard housing materials	Aluminum
Temperature range	-40° to 120°C (-40° to 248°F)
Fluids	All general purpose hydraulic fluids such as: MIL-H-5606, SAE 10, SAE 20, etc.
Filtration	Cleanliness code 18/16/13
Weight cartridge and coil	0,43 kg (0.95 lbs)
Seal kits	565810 (Buna-N) 889609 (Viton®)

Viton is a registered trademark of E.I. DuPont

Pressure Override Characteristics

Pressure gain curve

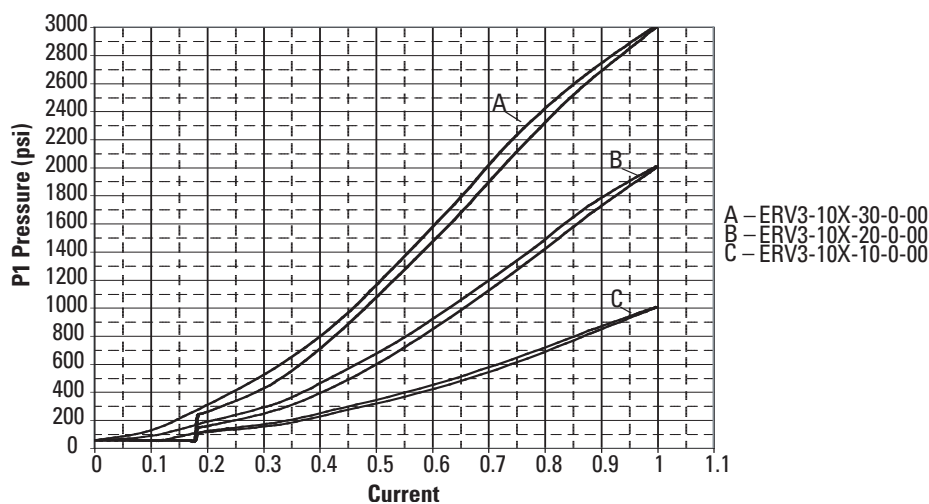

A - ERV3-10X-30-0-00
B - ERV3-10X-20-0-00
C - ERV3-10X-10-0-00

ERV3 - 10 (V) - ** - * - *** - * - * - 00**

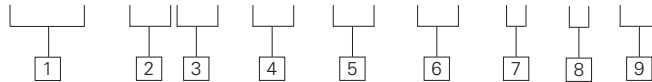

1 Function

ERV3 - Proportional relief valve (high pressure)

2 Size

10 - 10 Size

3 Seals

Blank - Buna-N
V - Viton®

4 Maximum pressure (factory set)

Customer to specify settings in increments of 7 bar (100 psi) and coded in hundreds of psi within the 35-210 bar range (500-3000 psi) range.

Example: **5** - 35,0 (500 psi)

6 Voltage rating

- 00** - No coil
- 12D** - 12VDC
- 24D** - 24VDC
- 12B** - 12VDC/w diode*
- 24B** - 24VDC/w diode*

*Optional arc suppressing diode.

Note: This valve uses the standard J series coils, see section C for coil part numbers and specifications.

5 Port size

0 - Cartridge only

CODE	PORT SIZE	HOUSING NUMBER
A6T	SAE 6	566151*
A2G	1/4" BSPP	876702
A3G	3/8" BSPP	876703
A6H	SAE 6	876700
A8H	SAE 8	876701

*Light duty housing.
See section J for housings.

7 Connector Types

- Blank** - No coil
- G** - DIN 43650
- Q** - Spade terminals
- W** - Leadwire
- N** - Deutch
- Y** - Amp JR

8 Coil Series

- Blank** - No Coil
- J** - J Series Coil

9 Special Features

- 00** - None
- Blank** - No Coil

(Only required when valve has special features, omitted if "00.")



WARNING

Maintain 5-8 Nm (4-6 ft. lbs) maximum torque on valve tube nut. Over tightening may cause valve failure.

Dimensions

mm (inch)

Torque cartridge in aluminum housing
47-54 Nm (35-40 ft. lbs)

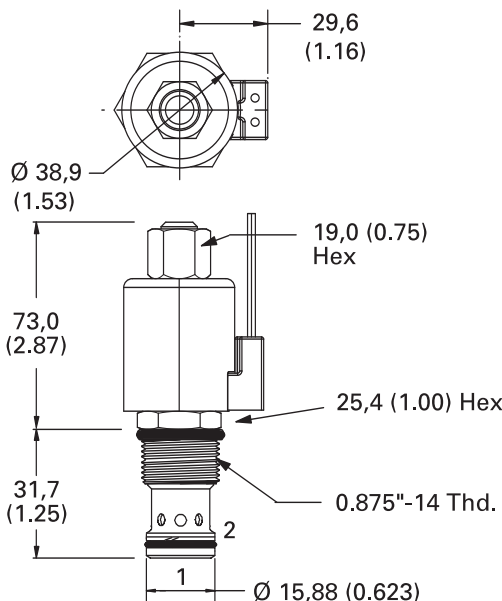

Valve is shown with "W" coil.

Performance Characteristics

Step Response Curve

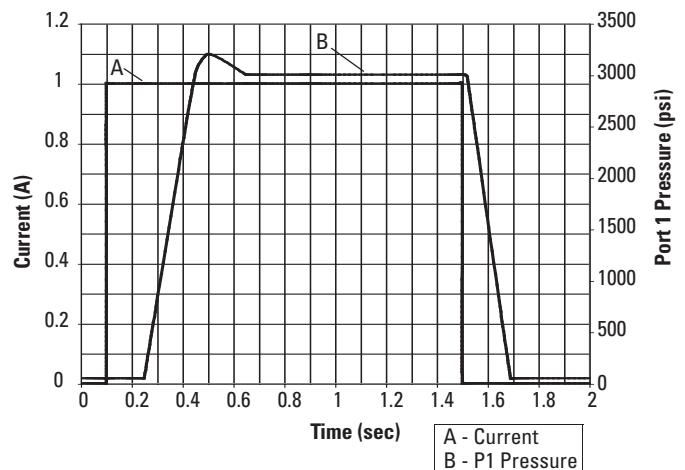

ERV1-10

Proportionally controlled pressure relief valve

Description

The ERV1-10 is an electric, proportionally controlled, internally pilot operated, spool type, screw-in relief valve.

Operation

This valve remains closed between port 1 and 2 until the predetermined pressure setting has been reached at port 1, overcoming the electrical force and opening the spool to allow flow from port 1 to port 2.

Functional Symbol

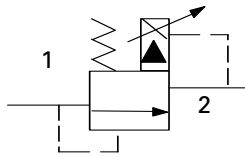

Sectional View

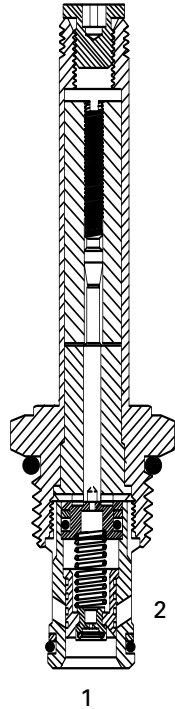

RATINGS AND SPECIFICATIONS

Performance data is typical with fluid at 21,8 cSt (105 SUS) and 49°C (120°F)

Typical application pressure (all ports)	2 - 240 bar (30 - 3500 psi)
Cartridge fatigue pressure (infinite life)	240 bar (3500 psi)
Rated flow	3,8 - 60,0 L/min (1 - 15 USgpm)
Cavity	C-10-2
Standard housing materials	Aluminum
Temperature range	-40° to 120°C (-40° to 248°F)
Fluids	All general purpose hydraulic fluids such as: MIL-H-5606, SAE 10, SAE 20, etc.
Filtration	Cleanliness code 18/16/13
Weight cartridge and coil	0,44 kg (0.98 lbs)
Seal kits	565803 (Buna-N) 565086 (Viton®)

Viton is a registered trademark of E.I. DuPont

Pressure Override Characteristics

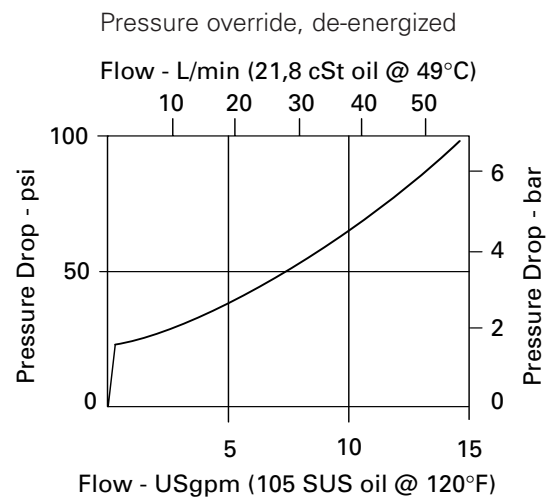
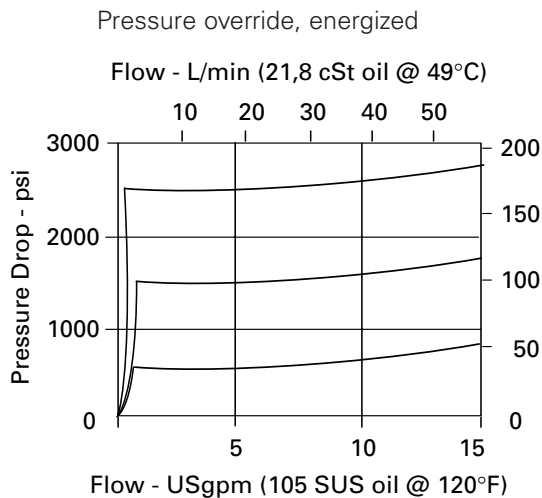

ERV1 - 10 (V) - ** - ** - * - * - 00**

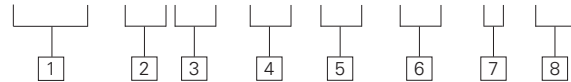

1 Function

ERV1 - Proportional relief valve

2 Size

10 - 10 Size

3 Seals

Blank - Buna-N
V - Viton®

4 Maximum pressure (factory set)

Customer to specify settings in increments of 7 bar (100 psi) and coded in hundreds of psi within the 35-210 bar range (500-3000 psi) range.

Example: **5** - 35,0 (500 psi)

6 Voltage rating

- 00** - No coil
- 12D** - 12VDC
- 24D** - 24VDC
- 12B** - 12VDC/w diode*
- 24B** - 24VDC/w diode*

*Optional arc suppressing diode.

Note: This valve uses the standard J series coils, see section C for coil part numbers and specifications.

5 Port size

0 - Cartridge only

CODE	PORT SIZE	HOUSING NUMBER
6T	SAE 6	566151*
2G	1/4" BSPP	876702
3G	3/8" BSPP	876703
6H	SAE 6	876700
8H	SAE 8	876701

*Light duty housing. See section J for housings.

7 Connector Types

- Blank** - No coil
- G** - DIN 43650
- Q** - Spade terminals
- W** - Leadwire
- N** - Deutsch
- Y** - Amp JR

8 Special Features

00 - None
(Only required when valve has special features, omitted if "00.")



WARNING

Maintain 5-8 Nm (4-6 ft. lbs) maximum torque on valve tube nut. Over tightening may cause valve failure.

Dimensions

mm (inch)
Torque cartridge in aluminum housing 47-54 Nm (35-40 ft. lbs)

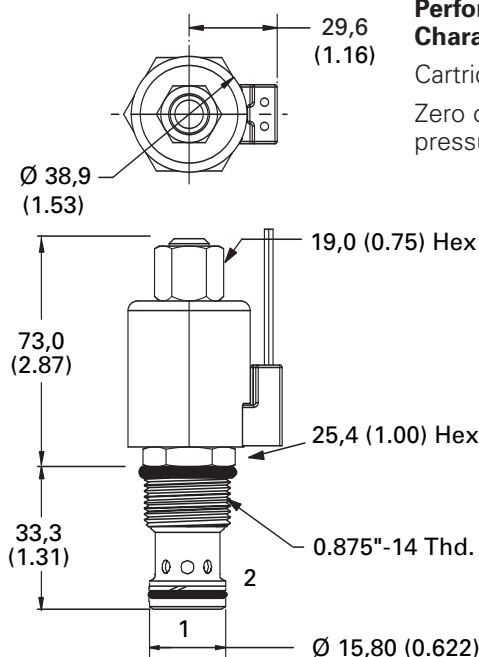

Valve is shown with "W" coil.

Performance Characteristics

Cartridges only
Zero outlet pressure

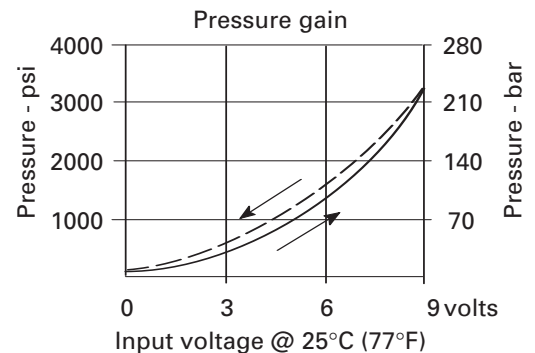
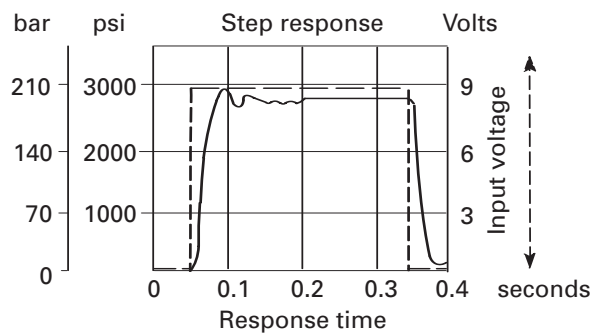

ERV1-16

Proportionally controlled pressure relief valve

Description

The ERV1-16 is an electric, proportionally controlled, internally pilot operated, spool type, screw-in relief valve.

Operation

This valve remains closed between port 1 and 2 until the predetermined pressure setting has been reached at port 1, overcoming the electrical force and unseating the spool to allow flow from port 2.

Functional Symbol

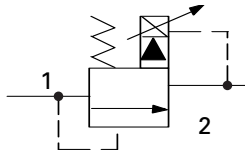

Sectional View

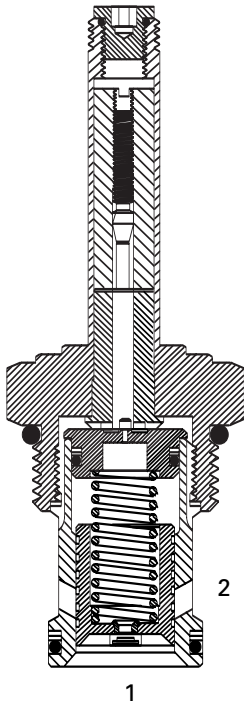

RATINGS AND SPECIFICATIONS

Performance data is typical with fluid at 21,8 cSt (105 SUS) and 49°C (120°F)

Typical application pressure (all ports)	3,5 - 210 bar (50 - 3000 psi)
Cartridge fatigue pressure (infinite life)	210 bar (3000 psi)
Rated flow	7,6 - 132,0 L/min (2 - 35 USgpm)
Cavity	C-16-2
Standard housing materials	Aluminum
Temperature range	-40° to 120°C (-40° to 248°F)
Fluids	All general purpose hydraulic fluids such as: MIL-H-5606, SAE 10, SAE 20, etc.
Filtration	Cleanliness code 18/16/13
Weight cartridge and coil	0,44 kg (0.98 lbs)
Seal kits	565810 (Buna-N) 889609 (Viton®)

Viton is a registered trademark of E.I. DuPont

Pressure Override Characteristics

Pressure override, energized

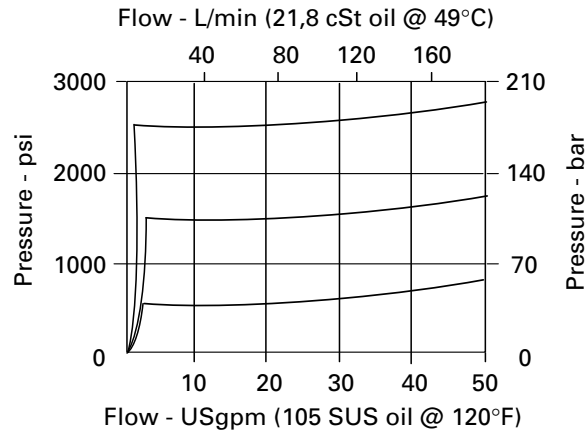

Pressure override, de-energized

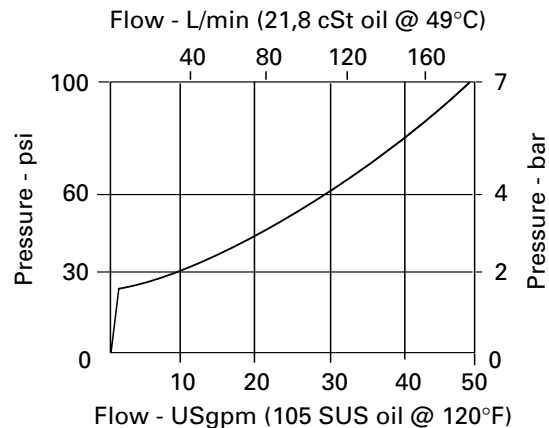

ERV1 - 16 (V) - ** - * - *** - * - 00**

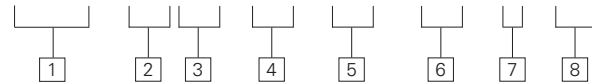

1 Function
ERV1 - Proportional relief valve

2 Size
16 - 16 Size

3 Seals
Blank - Buna-N
V - Viton®

WARNING
 Maintain 5-8 Nm (4-6 ft. lbs) maximum torque on valve tube nut. Over tightening may cause valve failure.

4 Maximum pressure (factory set)
 Customer to specify settings in increments of 7 bar (100 psi) and coded in hundreds of psi within the 35-210 bar range (500-3000 psi) range.
 Example: **5** - 35,0 (500 psi)

6 Voltage rating
00 - No coil
12D - 12VDC
24D - 24VDC
12B - 12VDC/w diode*
24B - 24VDC/w diode*
 *Optional arc suppressing diode.
 Note: This valve uses the standard J series coils, see section C for coil part numbers and specifications.

5 Port size
0 - Cartridge only

CODE	PORT SIZE	HOUSING NUMBER
12T	SAE 12	566149*
4G	1/2" BSPP	876716
6G	3/4" BSPP	876718
10H	SAE 10	876717
12H	SAE 12	566113

*Light duty housing. See section J for housings.

7 Connector Types
Blank - No coil
G - DIN 43650
Q - Spade terminals
W - Leadwire
N - Deutch
Y - Amp JR

8 Special Features
00 - None
 (Only required when valve has special features, omitted if "00.")

Dimensions

mm (inch)
 Torque cartridge in aluminum housing
 108-122 Nm (80-90 ft. lbs)

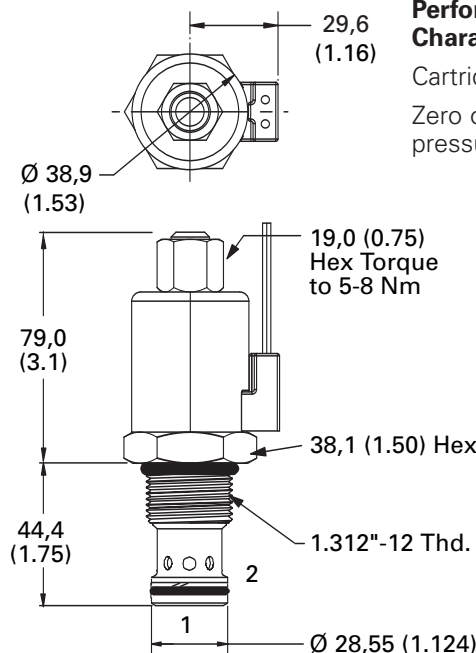

Valve is shown with "W" coil.

Performance Characteristics

Cartridges only
 Zero outlet pressure

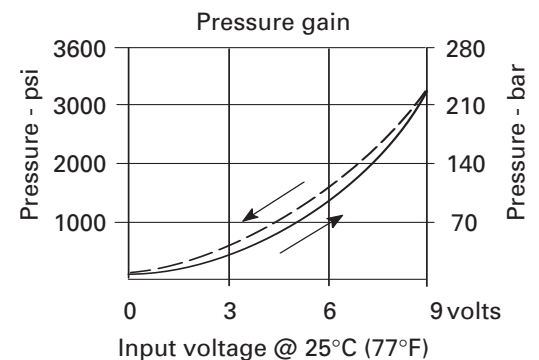
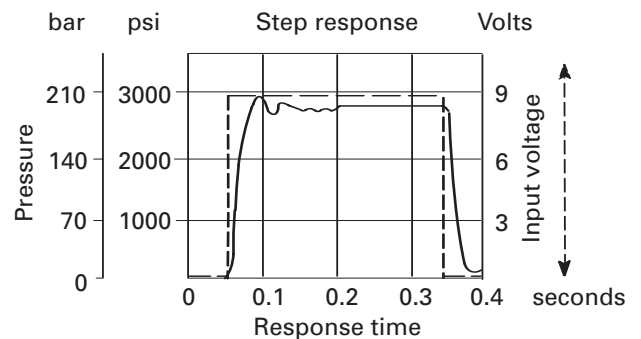

EPRV2-8

Proportional pressure reducing-relieving valve

Description

The EPRV2-8 is a proportional, pressure reducing-relieving, sliding spool, electrically controlled, screw-in cartridge type valve.

Operation

In the de-energized position, pressure inlet port 2 is closed and reduced pressure port 1 is open to return port 3. As electrical current

is increased, port 2 opens to port 1 and port 3 closes, proportionally increasing pressure at port 1. If the pressure at port 1 exceeds

the setting of the valve, the spool will shift further and relieve to port 3.

Functional Symbol

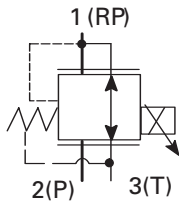

Sectional View

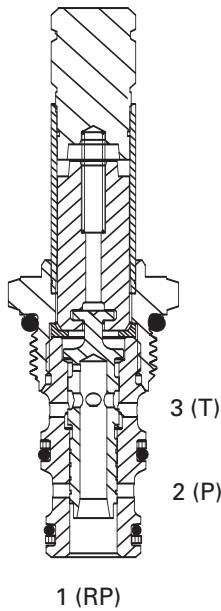

RATINGS AND SPECIFICATIONS

Performance data is typical with fluid at 21,8 cSt (105 SUS) and 49°C (120°F)

Maximum inlet pressure	35 bar (500 psi)
Cartridge fatigue pressure (infinite life)	35 bar (500 psi)
Reduced pressure range	0 - 22 bar (0 - 320 psi)
Maximum operating flow	7,6 L/min (2 USgpm)
Cavity	C-8-3
Standard housing materials	Aluminum
Temperature range	-40° to 120°C (-40° to 248°F)
Fluids	All general purpose hydraulic fluids such as: MIL-H-5606, SAE 10, SAE 20, etc.
Filtration	Cleanliness code 18/16/13
Recommended PWM frequency	150 Hz
Hysteresis @ 150 Hz PWM	5%
Weight including coil	0,29 kg (0.64 lbs)
Seal kits	02-179451 (Buna-N) 02-179452 (Viton®)

Viton is a registered trademark of E.I. DuPont

Pressure Characteristics

Pressure drops vs flow

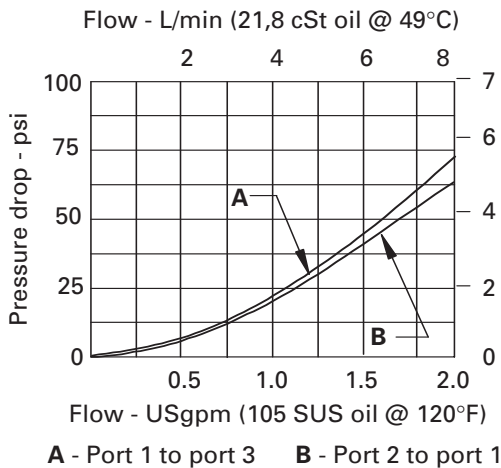

Pressure drops vs flow

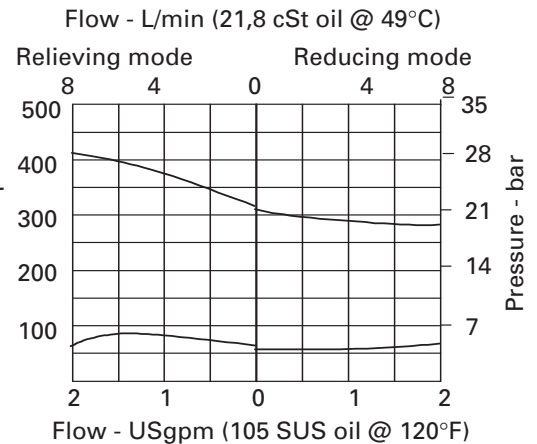

EPRV2 - 8 (V) - (A) - ** - * - * * - 00**

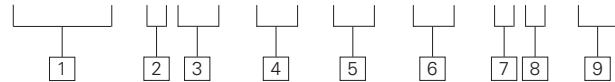

1 Function
EPRV2 - Proportional reducing/relieving valve

2 Size
8 - 8 Size

3 Seals
Blank - Buna-N
V - Viton®

4 Valve housing material
 Omit for cartridge only
A - Aluminum

6 Voltage rating
00 - No coil
12D - 12VDC
24D - 24VDC
12B - 12VDC/w diode*
24B - 24VDC/w diode*
 *Optional arc suppressing diode.
 Note: This valve uses the standard S series, coils, see section C for part numbers and specifications.

5 Port size
0 - Cartridge only

CODE	PORT SIZE	HOUSING NUMBER
4T	SAE 4	02-160741
6T	SAE 6	02-160742
2G	1/4" BSPP	02-160739
3G	3/8" BSPP	02-160740

See section J for housings.

7 Connector Types
Blank - No coil
G - DIN 43650
Q - Spade terminals
W - Leadwire
N - Deutch
Y - Amp JR

8 Coil
S - S Series Coils

9 Special Features
00 - None
 (Only required when valve has special features, omitted if "00.")

WARNING

 Maintain 5-8 Nm (4-6 ft. lbs) maximum torque on valve tube nut. Over tightening may cause valve failure.

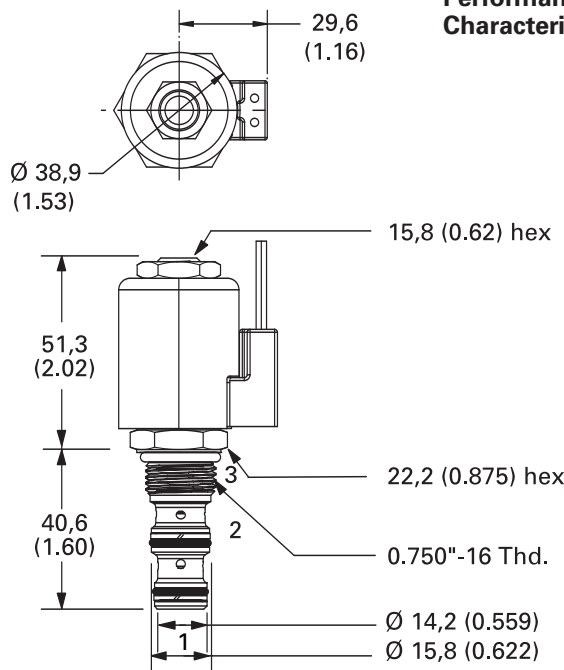
Dimensions
 mm (inch)
 Torque cartridge in aluminum or steel housing
 34-41 Nm (25-30 ft. lbs)

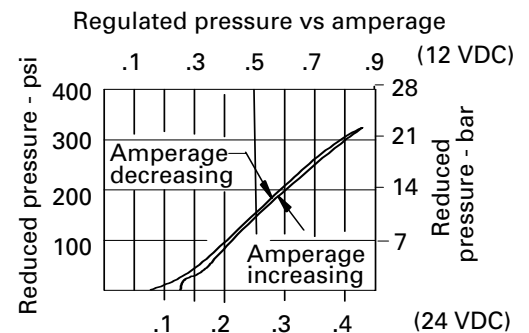
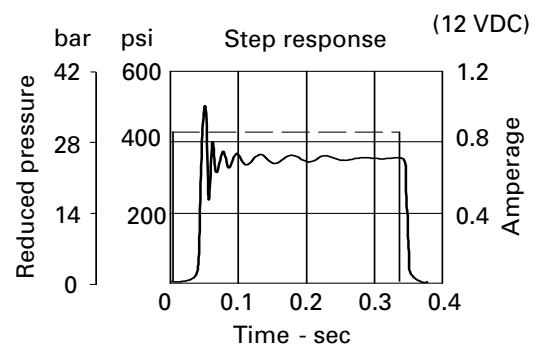

Valve is shown with "N" coil.

Performance Characteristics



EPRV1-10

Proportional pressure reducing-relieving valve

Description

The EPRV1-10 is an electric, proportionally controlled, internally pilot operated, spool type, screw-in relief valve.

Operation

This valve remains open from port 2 to port 1 (port 3 must be vented). Once the predetermined pressure is reached at port 1,

the spool shifts to restrict the inlet flow at port 2, which regulates the pressure at port 1. If the pressure at port 1

exceeds the setting of the valve, the spool will shift farther and relieve to port 3.

Functional Symbol

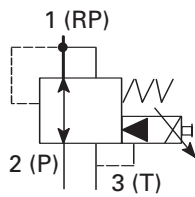

Sectional View

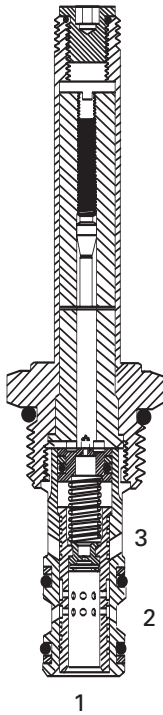

RATINGS AND SPECIFICATIONS

Performance data is typical with fluid at 21,8 cSt (105 SUS) and 49°C (120°F)

Typical application pressure (all ports)	3,5 - 35 bar (50 - 500 psi)
Cartridge fatigue pressure (infinite life)	35 bar (500 psi)
Rated flow	0 - 7,6 L/min (0 - 2.0 USgpm)
Cavity	C-10-3
Standard housing materials	Aluminum
Temperature range	-40° to 120°C (-40° to 248°F)
Fluids	All general purpose hydraulic fluids such as: MIL-H-5606, SAE 10, SAE 20, etc.
Filtration	Cleanliness code 18/16/13
Weight cartridge and coil	0,44 kg (0.98 lbs)
Seal kits	565804 (Buna-N) 889599 (Viton®)

Viton is a registered trademark of E.I. DuPont

Pressure Override Characteristics

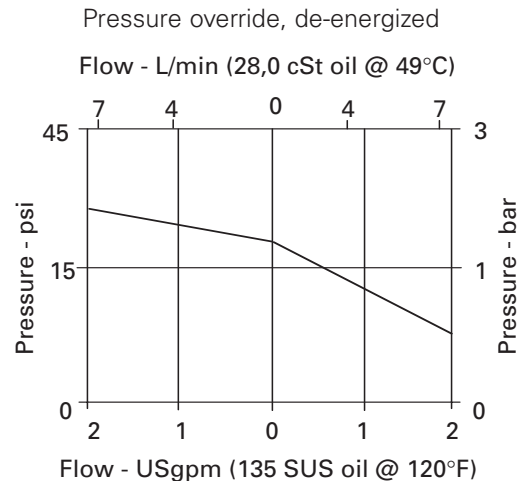
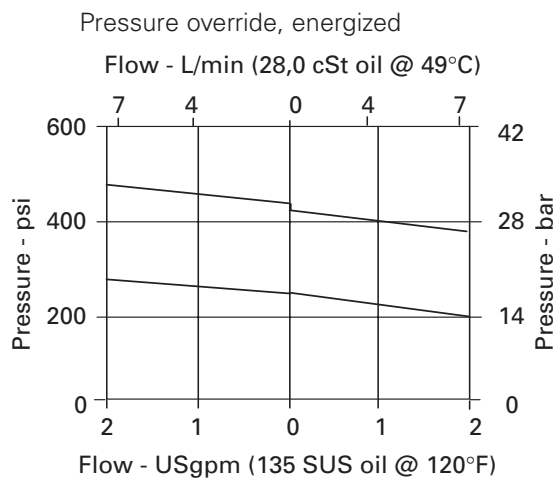

EPRV1 - 10 (V) - ** - ** - * * - 00**

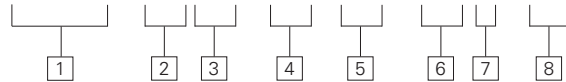

1 Function
EPRV1 - Proportional reducing/relieving valve

2 Size
10 - 10 Size

3 Seals
Blank - Buna-N
V - Viton®

WARNING
 Maintain 5-8 Nm (4-6 ft. lbs) maximum torque on valve tube nut. Over tightening may cause valve failure.

4 Maximum pressure (factory set)
 Customer to specify settings in increments of 7 bar (100 psi) and coded in hundreds of psi within the 14-35 bar range (200-500 psi) range.
 Example: **5** - 35,0 (500 psi)

6 Voltage rating
00 - No coil
12D - 12VDC
24D - 24VDC
36D - 36VDC
12B - 12VDC/w diode*
24B - 24VDC/w diode*
 *Optional arc suppressing diode.
 Note: This valve uses the standard J series coils, see section C for coil part numbers and specifications.

5 Port size
0 - Cartridge only

CODE	PORT SIZE	HOUSING NUMBER
3B	3/8" BSPP	02-173358*
6T	SAE 6	566162*
2G	1/4" BSPP	876702
3G	3/8" BSPP	876714
6H	SAE 6	876704
8H	SAE 8	876711

*Light duty housing. See section J for housings.

7 Connector Types
Blank - No coil
G - DIN 43650
Q - Spade terminals
W - Leadwire
N - Deutch
Y - Amp JR

8 Special Features
00 - None
 (Only required when valve has special features, omitted if "00.")

Dimensions
 mm (inch)
 Torque cartridge in aluminum housing
 47-54 Nm (35-40 ft. lbs)

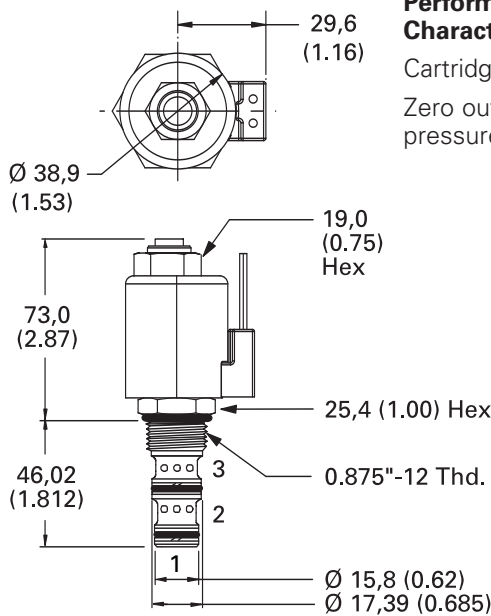

Valve is shown with "W" coil.

Performance Characteristics
 Cartridges only
 Zero outlet pressure

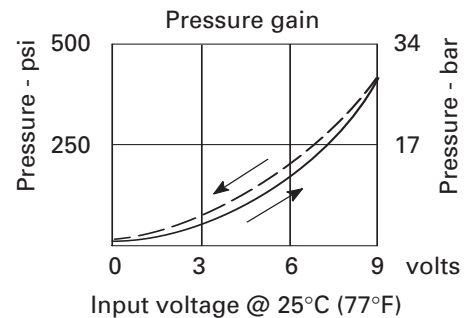
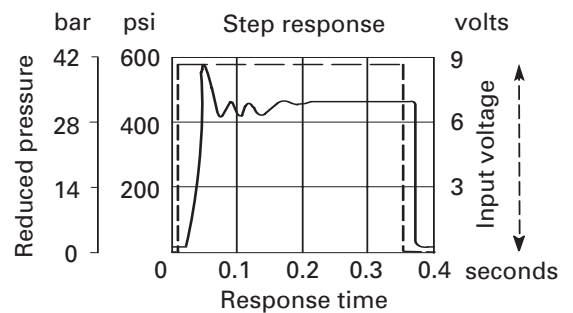

EPRV3-10

Proportional pressure
reducing-relieving valve

Description

The EPRV3-10 is an electric, proportionally controlled, internally pilot operated, spool type, screw-in relief valve.

Operation

This valve remains open from port 2 to port 1 (port 3 must be vented). Once the predetermined pressure is reached at port 1,

the spool shifts to restrict the inlet flow at port 2, which regulates the pressure at port 1. If the pressure at port 1

exceeds the setting of the valve, the spool will shift farther and relieve to port 3.

Functional Symbol

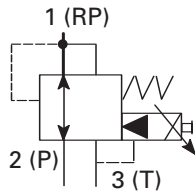

Sectional View

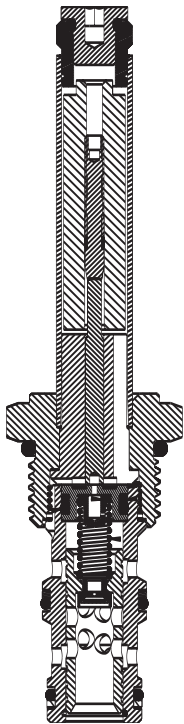

RATINGS AND SPECIFICATIONS

Performance data is typical with fluid at 21,8 cSt (105 SUS) and 49°C (120°F)

Typical application pressure (all ports)	3,5 - 207 bar (50 - 3000 psi)
Maximum Inlet Pressure	240 bar (3500 psi)
Cartridge fatigue pressure (infinite life)	207 bar (3000 psi)
Rated flow	30 L/min (8 USgpm)
Cavity	C-10-3
Standard housing materials	Aluminum
Temperature range	-40° to 120°C (-40° to 248°F)
Fluids	All general purpose hydraulic fluids such as: MIL-H-5606, SAE 10, SAE 20, etc.
Filtration	Cleanliness code 18/16/13
Weight cartridge and coil	0,44 kg (0.98 lbs)
Seal kits	565804 (Buna-N) 889599 (Viton®)

Viton is a registered trademark of E.I. DuPont

Pressure Override Characteristics

Pressure override, energized

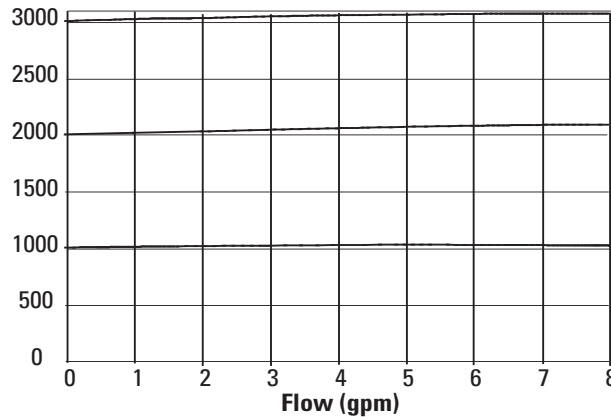

A – EPRV3-10X-30-0-00
B – EPRV3-10X-10-0-00
C – EPRV3-10X-20-0-00

Pressure override, de-energized

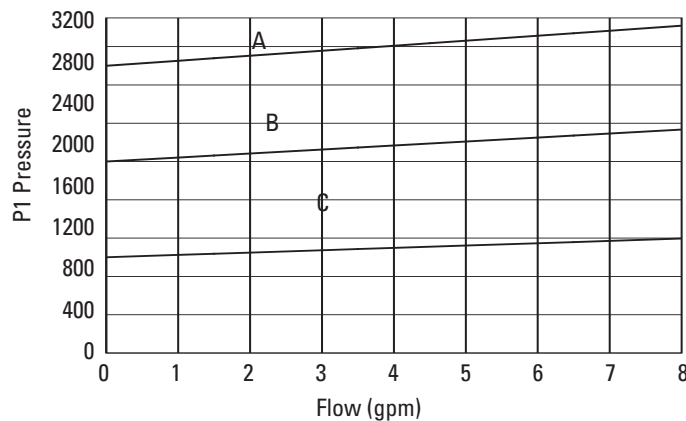

A – EPRV3-10X-10-0-00
B – EPRV3-10X-20-0-00
C – EPRV3-10X-30-0-00

EPRV3 - 10 (V) - ** - ** - * * - 00**

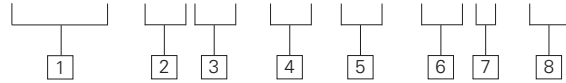

1 Function

EPRV3 - Proportional reducing/relieving valve

2 Size

10 - 10 Size

3 Seals

Blank - Buna-N
V - Viton®



WARNING

Maintain 5-8 Nm (4-6 ft. lbs) maximum torque on valve tube nut. Over tightening may cause valve failure.

4 Maximum pressure (factory set)

Customer to specify settings in increments of 7 bar (100 psi) and coded in hundreds of psi within the 35-207 bar range (500-3000 psi) range.

Example: **5** - 35,0 (500 psi)

6 Voltage rating

- 00** - No coil
- 012D** - 12VDC
- 024D** - 24VDC
- 012B** - 12VDC/w diode*
- 024B** - 24VDC/w diode*

*Optional arc suppressing diode.

Note: This valve uses the standard J series coils, see section C for coil part numbers and specifications.

5 Port size

0 - Cartridge only

CODE	PORT SIZE	HOUSING NUMBER
A3B	3/8" BSPP	02-173358*
A6T	SAE 6	566162*
A2G	1/4" BSPP	876702
A3G	3/8" BSPP	876714
A6H	SAE 6	876704
A8H	SAE 8	876711

*Light duty housing. See section J for housings.

7 Connector Types

- Blank** - No coil
- G** - DIN 43650
- Q** - Spade terminals
- W** - Leadwire
- N** - Deutch
- Y** - Amp JR

8 Coil Series

- Blank** - No coil
- J** - J series coil

9 Coil Special Features

- 00** - None
- (Only required when valve has special features, omitted if "00.")

Dimensions

mm (inch)

Torque cartridge in aluminum housing
47-54 Nm
(35-40 ft. lbs)

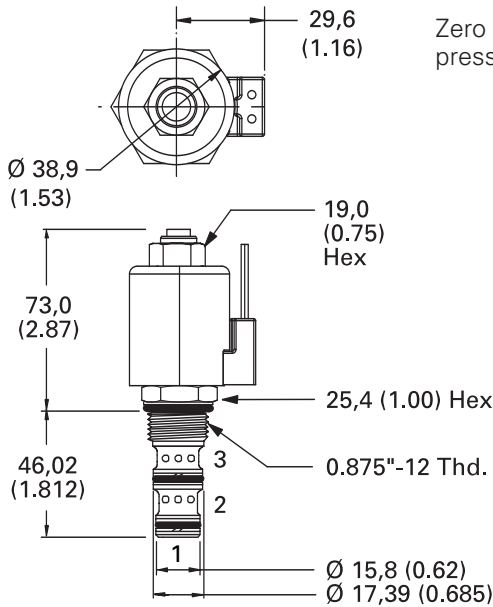

Valve is shown with "W" coil.

Performance Characteristics

Cartridges only
Zero outlet pressure

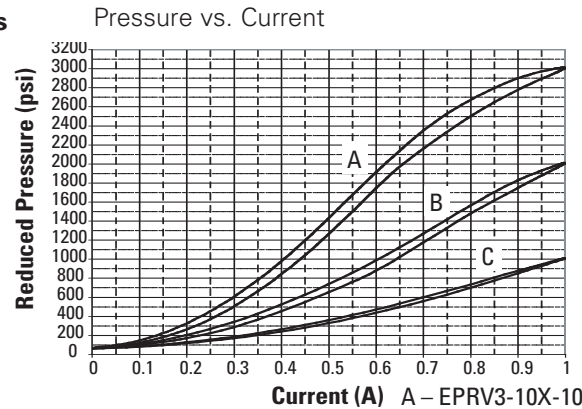

Step Response Curve

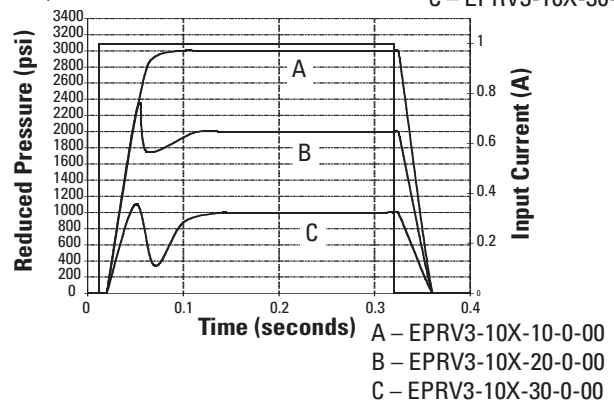

EPRV1-16

Proportional pressure reducing-relieving valve

Description

The EPRV1-16 is an electric, proportionally controlled, internally pilot operated, spool type, screw-in relief valve.

Operation

This valve remains open from port 2 to port 1 (port 3 must be vented). Once the predetermined pressure is

reached at port 1, the spool shifts to restrict the inlet flow at port 2, which regulates the pressure at port 1.

If the pressure at port 1 exceeds the setting of the valve, the spool will shift farther and relieve to port 3.

Functional Symbol

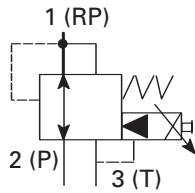

Sectional View

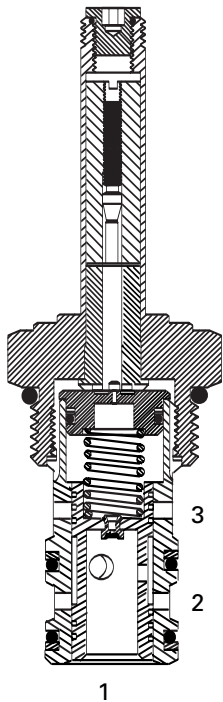

RATINGS AND SPECIFICATIONS

Performance data is typical with fluid at 21,8 cSt (105 SUS) and 49°C (120°F)

Typical application pressure (all ports)	3,5 - 35 bar (0 - 500 psi)
Cartridge fatigue pressure (infinite life)	35 bar (500 psi)
Rated flow	0 - 38,0 L/min (0 - 10 USgpm)
Cavity	C-16-3
Standard housing materials	Aluminum
Temperature range	-40° to 120°C (-40° to 248°F)
Fluids	All general purpose hydraulic fluids such as: MIL-H-5606, SAE 10, SAE 20, etc.
Filtration	Cleanliness code 18/16/13
Weight cartridge and coil	0,9 kg (2.00 lbs)
Seal kits	565811 (Buna-N) 889599 (Viton®)

Viton is a registered trademark of E.I. DuPont

Pressure Override Characteristics

Pressure override, energized

Flow - L/min (28,0 cSt oil @ 49°C)

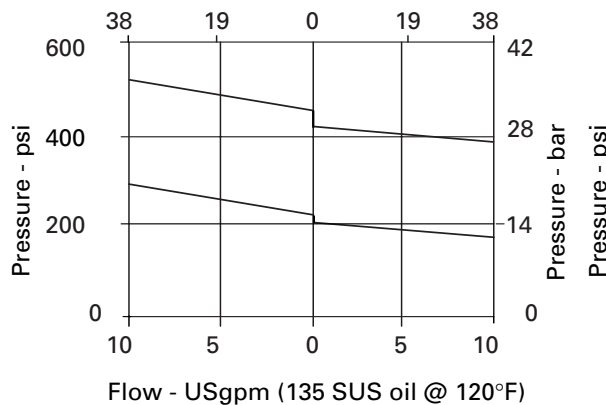

Pressure override, de-energized

Flow - L/min (28,0 cSt oil @ 49°C)

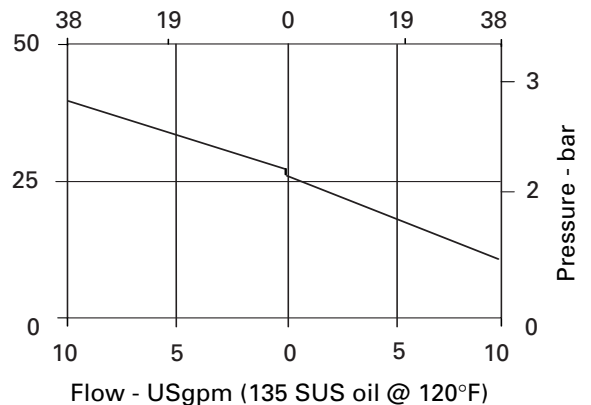

EPRV1 - 16 (V) - ** - * - *** - * - 00**

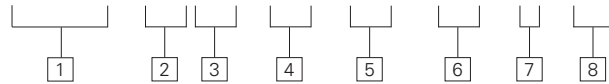

1 Function
EPRV1 - Proportional reducing/relieving valve

2 Size
16 - 16 Size

3 Seals
Blank - Buna-N
V - Viton®

WARNING
 Maintain 5-8 Nm (4-6 ft. lbs) maximum torque on valve tube nut. Over tightening may cause valve failure.

4 Maximum pressure (factory set)
 Customer to specify settings in increments of 7 bar (100 psi) and coded in hundreds of psi within the 14-35 bar range (200-500 psi) range.
 Example: **5** - 35,0 (500 psi)

6 Voltage rating
00 - No coil
12D - 12VDC
24D - 24VDC
36D - 36VDC
12B - 12VDC/w diode*
24B - 24VDC/w diode*
 *Optional arc suppressing diode.
 Note: This valve uses the standard J series coils, see section C for coil part numbers and specifications.

5 Port size
0 - Cartridge only

CODE	PORT SIZE	HOUSING NUMBER
6B	3/4" BSPP	02-175465*
12T	SAE 12	566162*
6G	3/4" BSPP	876722
10H	SAE 10	876721
12H	SAE 12	876723

*Light duty housing. See section J for housings.

7 Connector Types
Blank - No coil
G - DIN 43650
Q - Spade terminals
W - Leadwire
N - Deutch
Y - Amp JR

8 Special Features
00 - None
 (Only required when valve has special features, omitted if "00.")

Dimensions
 mm (inch)
 Torque cartridge in aluminum housing
 108-122 Nm (80-90 ft. lbs)

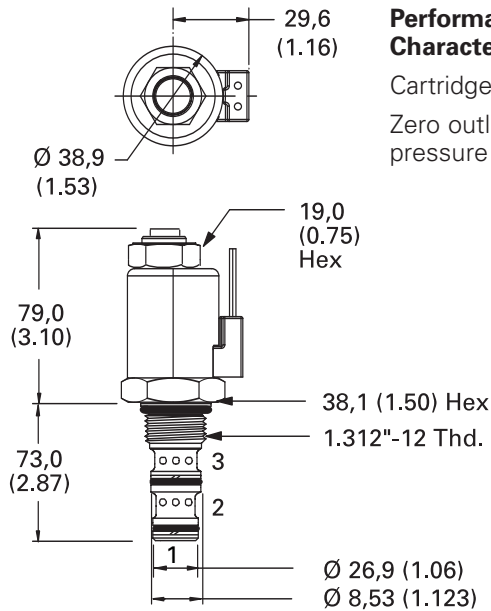

Valve is shown with "W" coil.

Performance Characteristics
 Cartridges only
 Zero outlet pressure

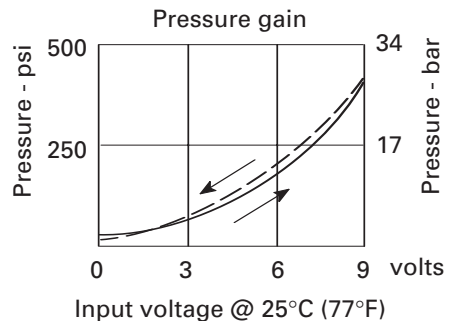
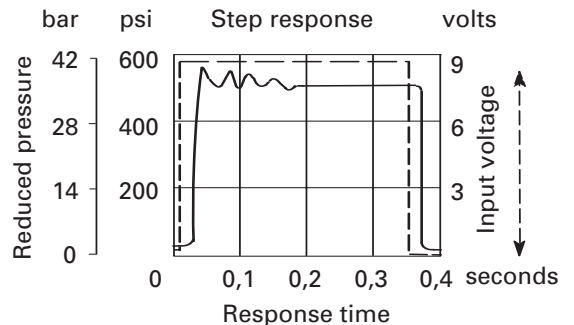

758 Series Proportional Flow Regulator Valve (Slip-in Type)

Proportional flow control valve

Description

The 758 Series Proportional Flow Regulator Valve is a proportional, flow control valve, designed for pilot control, applications.

Operation

In the de-energized position, port A is open to port T. As electrical current is increased, the opening between port A and port T is reduced and port P is opened to port A.

Functional Symbol

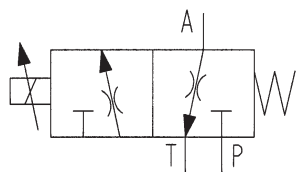

Sectional View

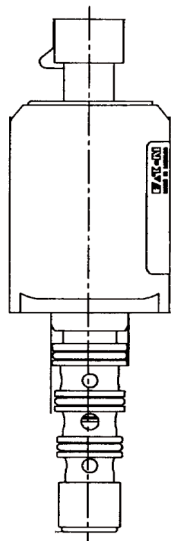

RATINGS AND SPECIFICATIONS

<i>Performance data is typical with fluid at 10 cSt (48 SUS) and 49°C (120°F)</i>	
Maximum inlet pressure	100 bar (1450 psi)
Cartridge fatigue pressure (infinite life)	100 bar (1450 psi)
Regulation	0 - 10 L/min (0 - 2 USgpm) * at 10 bar (145 psi) pressure drop
Maximum operating flow	10 L/min (2.6 USgpm)
Cavity	38118_0
Leakage (P, A → T)	< 10 cc/min
Temperature range	-30° to 125°C
Fluids	All general purpose hydraulic fluids such as: MIL-H-5606, SAE 10, SAE 20, etc.
Filtration	Cleanliness code 18/16/13
Hysteresis	< 8%
Weight including coil	220g (0.1 lbs)
Coil Resistance	2.5 ohm
Max Control Current	2 Amp
Electrical Connection	Metripac 150
Part Number	5986803-001

Regulation Curve

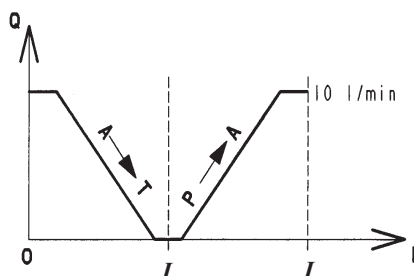

758 Series Proportional Flow Regulator Valve

B

Dimensions

mm

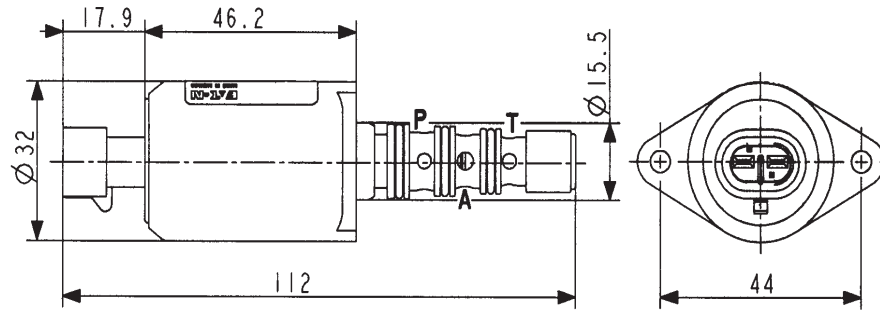

Cavity and Installation Details

mm

Cavity ref: 38118-0

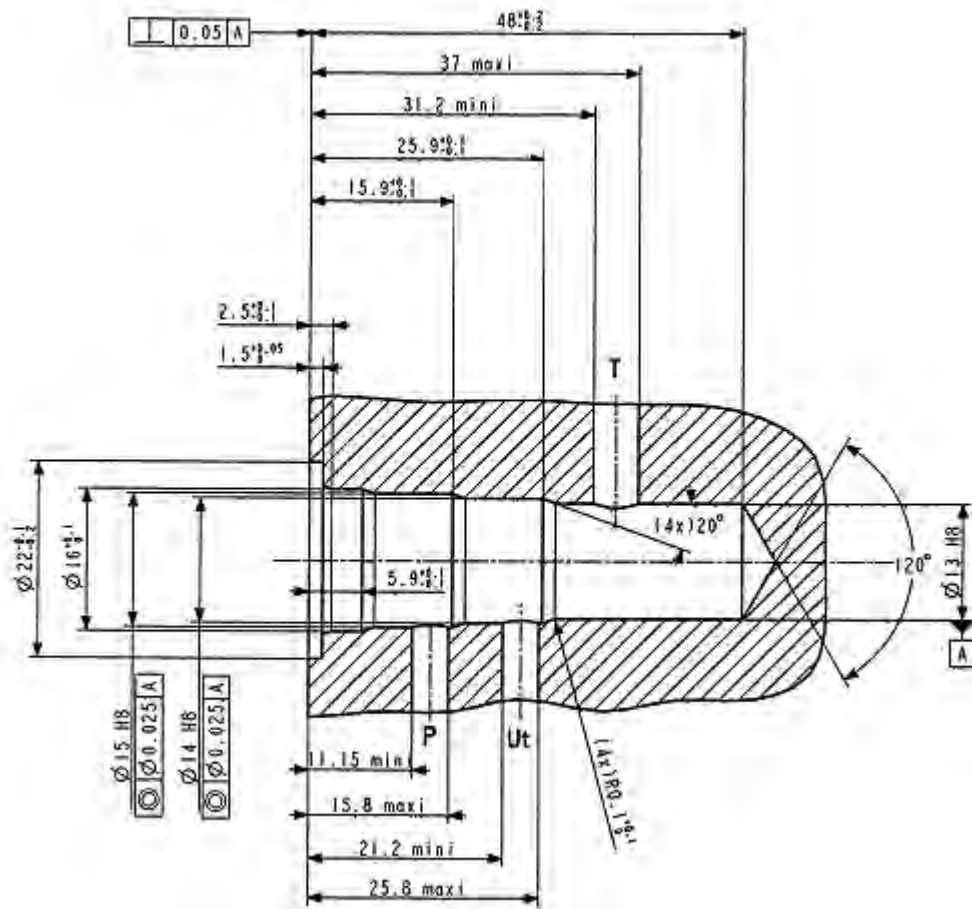

758 Series Proportional Pressure Control Valve (Slip-in Type)

Proportional pressure
reducing valve

Description

The 758 Series Proportional Pressure Control Valve is a proportional, pressure reducing-relieving valve designed for pilot control applications.

Operation

In the de-energized position, pressure inlet port P is closed and reduced pressure port A is open to return port T. As electrical current is increased, port A opens to port P and port T closes, proportionally increasing pressure at port A.

Functional Symbol

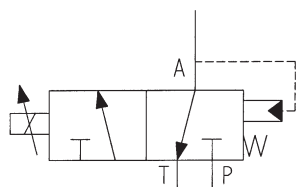

Sectional View

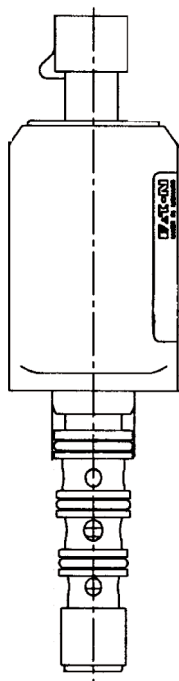

RATINGS AND SPECIFICATIONS

<i>Performance data is typical with fluid at 10 cSt (48 SUS) and 49°C (120°F)</i>	
Maximum inlet pressure	100 bar (1450 psi)
Cartridge fatigue pressure (infinite life)	100 bar (1450 psi)
Reduced pressure range	0 - 60 bar (0 - 870 psi)
Maximum operating flow	10 L/min (2.6 USgpm)
Cavity	38117_0 Special
Leakage (P, A → T)	< 10 cc/min
Temperature range	-30° to 125°C
Fluids	All general purpose hydraulic fluids such as: MIL-H-5606, SAE 10, SAE 20, etc.
Filtration	Cleanliness code 18/16/13
Hysteresis	< 4%
Weight including coil	220g (0.1 lbs)
Coil Resistance	2.5 ohm
Max Control Current	2.4 Amp
Response Time	0-60 bar < 20 ms 60-0 bar < 20 ms
Frequency response from 0.3 to 35 Hz	Pressure gain ± 3 dB Frequency phase < -90°C
Electrical Connection	Metripac 150
Part Number	4997994-001

Pressure Characteristics

Regulation Curve

